

Distributed Generation Connection Guide: G98 & G99

TBC 2023 | Version 1.0

DOCUMENT CONTROL

Authorities

Version	Issue Date	Authorisation	Comments
Draft	06/11/23		First Draft issued for Consultation

Related documents

Reference 1	
Reference 2	

Change history

Version	Change reference	Description

Distribution

--

TABLE OF CONTENTS

Energy Networks Association Introduction	15
About ENA	15
Our members and associates	15
ENA members	15
ENA associates	15
An Introduction to the Distributed Generation Guides	16
Who is this Guide for?	16
What is the aim of the Guide?	16
What is not covered in the Guide?	16
The format of the guide	16
Governance of the guide	17
Governance of related codes and documents	17
Section:	19
Contents:	19
Applicable for:	19
Engineering Recommendation G98	23
Engineering Recommendation G99	23
Micro-generator	23
Close Geographic Region	23
Inverters	23
Type tested equipment	24
Cyber Security	24
Equipment Certification	24
Emerging Technology	24
RfG Types A to D	25
Current Regulations	25
Requirements for Generators	25
Drivers for the Requirements for Generators	26
Electricity Storage	26
New approach to connections	26
Key terms for EREC G98 and G99	26

Section 1: A Guide to the GB Power Sector 28

Introduction	28
The Commercial Structure of the Power Sector	28
The Physical Infrastructure of The Power Sector	28
Key Organisations.....	29
Distribution Network Operator (DNO)	30
Independent Distribution Network Operators (IDNOs)	30
Transmission Owner (TO)	31
Private Networks	31
Suppliers	31
Aggregators	32
Energy Service Company (ESCO)	32
Generators	32
To identify your DNO or IDNO:	32
System Operator (SO)	33
Balancing Settlement Code company	34
Regulator	34
European organisations	34
Innovation Funding	34
Electricity Network Innovation Strategy	35
Transmission and Distribution Interfaces	35
Network Operation	36
Market Development	36
Planning and Network Development	36
New technologies.....	36
Where to Find More Information.....	37

Section 2: The Role of Distributed Generation 38

Introduction	38
What is driving Distributed Generation	38
Environmental concerns	38
Technological innovation	38
Government policy	38

Security of supply	39
Benefits of Distributed Generation.....	39
Impacts of Distributed Generation	40
Where to Find More Information.....	40

Section 3: Distribution Generation Connection Process	42
--	-----------

Section:	Error! Bookmark not defined.
Contents:	Error! Bookmark not defined.
Applicable for:	Error! Bookmark not defined.

Section 3.1: G98 Single Premises, An Overview of Getting Connected	48
---	-----------

Introduction	48
Getting Connected – Main Tasks	48
Finding an installer	48
Installation and Commissioning	49
Informing the DNO	49
Ongoing responsibilities	49
Getting Connected – IDNO’s Networks	49

Section 3.2: G98 Multiple Premises, An Overview of Getting Connected	51
---	-----------

Introduction	51
Getting Connected – Main Tasks	52
Finding an installer	52
Discussions with the DNO	52
Submitting an application form	52
Application acceptance	52
Installation and Commissioning	53
Informing the DNO	53
Ongoing responsibilities	53
Getting Connected – IDNO’s Networks	53
Customer Service and Provision of Information.....	54
Price Control Proposals (RIIO-ED2)	54

Guaranteed Standards of Performance	54
DER Forum	54
Improvements made to DNO Services	54

Section 3.3: G99 Type A, An Overview of Getting Connected.....	56
---	-----------

Introduction	56
Getting Connected – Main Tasks	57
Finding an installer.....	57
Discussions with the DNO.....	58
Alternative Connections	58
Make contact with the DNO	58
Feasibility studies (Optional)	58
Decide who will construct the connection.....	58
Submitting an application form	58
Application acceptance	59
Enter into agreements with the DNO	59
Compliance	59
Installation and Commissioning	60
Informing the DNO.....	60
Put commercial arrangements in place	60
Ongoing responsibilities	60
Management of DNO Connection Queues:.....	61
Changes to your Power Generating Module	61
Getting Connected – IDNO’s Networks	61

Section 3.4: G99 Type B-D, An Overview of Getting Connected	63
--	-----------

Introduction	63
Connection Process Overview	63
Getting Connected – Project Planning Phase	65
Identify your DNO (refer to Table 5).....	65
Alternative Connections	65
Make contact with the DNO	65
Feasibility studies (Optional)	65

Long Term Development Statement (LTDS)	65
Getting Connected - Information Phase	65
Initial meeting and communication with DNO	66
Decide who will construct the connection	66
Contestable and non-contestable work	66
Getting Connected – Design Phase	66
Submit a formal Connection Application	67
The Connection Offer	67
Formal Agreement	67
Standard Licence Condition 15 (SLC15)	68
Section 16 of the Electricity Act	68
Getting Connected – Construction Phase	70
Enter into agreements with the DNO	70
Submit a draft PGMD	70
Management of DNO Connection Queues:	70
Communicate with the DNO	70
Obtain an EON and an ION	70
Focus on other activities	71
Connection Agreements	71
Firm and Non-firm connections	71
Getting Connected – Testing and Commissioning	72
Provide the DNO with detailed information	72
Careful liaison with the DNO	72
Undertake commissioning tests	72
Put commercial arrangements in place	72
Getting Connected – Ongoing Responsibilities	73
Adoption Agreements	73
Changes to your Power Generating Module	73
Getting Connected – Medium and Large Stations	73
Registered Capacity Definition	74
Getting Connected – IDNO’s Networks	75
The Distribution Code	76
Where to Find More Information	76

Section 3.5: G99 Type A & Type B-D, An Overview of Getting Connected	78
In this section:	78
Types of Power Generating Module	78
Power Park Modules and Synchronous Power Generating Modules	78
New and Existing Generation	80
Power Park Modules	80
Synchronous Power Generating Modules	80
All Power Generating Modules	80
The Connection Point and Interface Protection	80
Customer Service and Provision of Information.....	80
Price Control Proposals (RIIO-ED2)	80
Guaranteed Standards of Performance	80
DER Forum	81
Improvements made to DNO Services	81
Section 3.6: G98 & G99, An Overview of Getting Connected	82
In this section	82
Getting Connected – Energy Storage.....	82
Energy Storage operation:	82
Getting Connected – EREC G98 Exceptions	82
EREC G98 exceptions	83
Getting Connected	83
Supply issues	83
Health and safety considerations	83
Getting Connected – Vehicle to Grid	83
Where to Find More Information.....	84
Dealing with disputes	84
Manufacturers’ Information	84
Section 4: The Connection Application Process	86
Section 4.1: G98 Single Premises, The Connection Application Process	86

Introduction	86
The Installation Document.....	86
Other Requirements.....	86

Section 4.2: G98 Multiple Premises, The Connection Application Process	87
---	-----------

Introduction	87
The Application for Connection Pro-forma.....	87
Installation and Commissioning.....	87
The Installation Document.....	87
Other Requirements.....	88

Section 4.3: G98 Single & Multiple Premises, The Connection Application Process	89
--	-----------

Getting Connected – Guidance on Compliance.....	89
ENA Type Test Register.....	89
Common errors on EREC G98 Form C (Type Test Verification Report) forms.....	89

Section 4.4: G99 Type A, The Connection Application Process	91
--	-----------

Introduction	91
The Standard Application Form.....	91
The Connection Offer.....	92
Connection Conditions	92
Flexible Connection Offers.....	92
Reactive Power Import / Export	93
Compliance Forms	93
The Installation Document.....	94
Other Requirements.....	94

Section 4.5: G98 Multiple Premises & G99 Type A, The Connection Application Process	95
--	-----------

Getting Connected – Guidance on Compliance.....	95
ENA Type Test Register	95
Type Test options	96
Common errors on forms	96
Power Quality assessments	97
Section 4.6: G99 Type B-D, The Connection Application Process	98
Introduction.....	98
The Connection Application Timeline.....	98
Notes on the timeline:	99
Initial Discussions with the DNO.....	100
Information about the Network.....	100
The Standard Application Form.....	100
Network Studies.....	101
How quickly must the DNO give me a Connection Offer?	101
The Connection Offer.....	102
Wayleaves for New Connections.....	102
Connection Conditions.....	103
Flexible Connection Offers	103
Reactive Power Import / Export	103
Interactive Connection Applications.....	103
Accepting a Connection Offer.....	104
For more information about Connection Offers and Interactive Applications	104
EREC G99 Additional Forms.....	104
Simulation studies	105
Site compliance and commissioning tests	105
Installation and Commissioning Confirmation	105
EREC G99 Notifications.....	105
Type B and C	105
Type D	106

Section 4.7: G99 Type B-D, The Connection Application Process – Generation Licensing	107
Introduction	107
Who Requires a Generation Licence?.....	107
Requirements for a Generation Licence	107
Applying for a Generation Licence	108
National Grid Interfaces.....	108
Definition of a Large Power Stations.....	109
Statement of Works Process	109
Where to Find More Information.....	110
Getting Connected – Guidance on Compliance.....	110
PGMD iterations.....	110
Compliance studies.....	111
Reactive Capability across Voltage Range.....	112
Fault Ride Through and Fast Fault Current Capability.....	113
Frequency studies.....	114
Validation studies.....	114
Providing simulation models	114
Section 5: Costs and Charges	116
Section 5.1: G98 Single Premises & G98 Multiple Premises, Costs and Charges	116
Use of System Charges	116
What are Use of System charges?	116
Categories of Use of System charges.....	116
Non-Half Hourly Meters (NHH)	117
Section 5.2: G98 Multiple Premises & G99 Type A, Costs and Charges	118
Introduction	118
Connection Charges	118

Connection Charges – Other Elements	118
Elements of charges	118
Indicative costs and examples.....	119
Estimating costs and getting a quotation.....	119
Payment of connection charges	119
Charging Futures Forum	119
What is a budget estimate?	120
Connection Offer expenses (Assessment and Design fees)	120
Section 5.3: G99 Type A, Costs and Charges	121
Use of System Charges	121
Definitions of LV, HV and EHV:	121
Metering Requirements, Parties and Charges.....	121
Metering requirements.....	121
Charges	122
Half Hourly (HH) meters and Non-Half Hourly (NHH) meters.....	122
Section 5.4: G99 Type B-D, Costs and Charges	124
Introduction	124
Connection Charges – Other Elements	124
Elements of charges	124
Indicative costs and examples.....	125
Connection Offer expenses (Assessment and Design fees)	125
Estimating costs and getting a quotation.....	126
Payment of connection charges	126
What is a budget estimate?	126
Transmission Connection Charges	127
Fault Level.....	127
Statement of Works.....	127
Transmission Impact Assessment (TIA).....	128
Financial liabilities associated with Transmission Works	128
Where to Find More Information.....	128
Ongoing Charges	129

Introduction	129
Generation Distribution Use of System Charges	130
Metering Requirements, Parties and Charges	130
Half Hourly (HH) meters and Non-Half Hourly (NHH) meters	131
Top-up and Standby Charges	131
Charges Applied by NGESO	132

Section 5.5: G99 Type A & Type B-D, Costs and Charges	134
Connection Charges – Infrastructure.....	134
Changes to Use of System Charges	135
Ofgem Targeted Charging Review	135
Embedded Benefits	137
Next Steps	138

Section 6: Selling Electricity (SEG)	139
Section 6.1: G98 & G99, Selling Electricity (SEG)	139
Introduction	139
Tariff Structure	139
FIT Scheme – Generation and Export Tariff	140
Metering Requirements	140
Eligibility and Accreditation.....	140
Accreditation steps:	140
Microgeneration Certification Scheme (MCS)	141
Where to Find More Information.....	141

Section 6.2: G99, Contracts for Difference	143
Introduction	143
Contracts for Difference (CFD).....	143
Introduction	143
Parties involved	143
Eligibility	144

CFD Allocation	144
Renewables Obligation	144
Where to Find More Information.....	144

Section 7: G99 Type B-D, Technical and Commercial Interfaces	146
---	------------

Introduction	146
DNO connections	146
ICP connections	146
Competition in Connection (CiC) Code of Practice (CoP)	146
Contestable and Non-contestable Work	146
National Electricity Registration Scheme	148
Practicalities of ICP Connections	148
Contracts and Agreements.....	149
Introduction	149
Connection Agreements	149
Adoption Agreements	149
Agreements with Other Parties	150
Agreements at a glance	150
Operational Issues	150
Introduction	150
Distribution Operating Code	151
DNO Control Schemes	152

Appendix A	156
-------------------	------------

Examples showing the process for inverter sizing and determining registered capacity.....	156
Example 1	156
Example 2:	156
Example 3:	157

² Classified as Confidential / Internal is optional to include in the footer. Just delete this part of the footer if you don't need to classify the document. Or you can update it as necessary.

Energy Networks Association Introduction

About ENA

Energy Networks Association (ENA) represents the companies which operate the electricity wires, gas pipes and energy system in the UK and Ireland.

We help our members meet the challenge of delivering electricity and gas to communities across the UK and Ireland safely, sustainably and reliably, as summarised below:

- Create smart grids, ensuring our networks are prepared for more renewable generation than ever before, decentralised sources of energy, more electric vehicles and heat pumps. Learn more about our [Open Networks programme](#).
- Create the world's first zero-carbon gas grid, by speeding up the switch from natural gas to hydrogen. Learn more about our [Gas Goes Green programme](#).
- Innovate. We're supporting over £450m of [innovation investment](#) to support customers, connections and more.
- Be safe. We bring our industry together to [improve safety](#) and reduce workforce and public injury.
- Manage our networks. We support our members manage, create and maintain a vast array of electricity codes, standards and regulations which supports the day-to-day operation of our energy networks.

Together, the energy networks are [keeping your energy flowing](#), supporting our economy through [jobs](#) and investment and [preparing for a net zero future](#).

Our members and associates

Our members include every major electricity and gas network operator in the UK and Ireland, independent operators, National Grid ESO which operates the electricity system in Great Britain and National Grid which operates the gas system in Great Britain. Our affiliate membership also includes companies with an interest in energy, including Heathrow Airport and Network Rail¹.

ENA members



ENA associates

- Chubu
- EEA
- Guernsey Electricity Ltd
- Heathrow Airport
- Jersey Electricity
- Manx Electricity Authority
- Network Rail
- TEPCO

An Introduction to the Distributed Generation Guides

Who is this Guide for?

This Guide is intended to help you, as a developer or the prospective owner of Distributed Generation, to connect your generating unit to a distribution network in Great Britain (GB). It may also be useful for installers or manufacturers of distributed generation equipment.

The types of generation that most frequently connect to the distribution networks include:

- renewable energy projects;
- waste to energy projects;
- energy storage devices (e.g. batteries); and
- on-site generation and Combined Heat and Power (CHP) projects.

What is the aim of the Guide?

The main aim of the Guide is to provide a 'route map' of the processes for getting a generation project connected to the distribution network. The Guide provides an overview of the connection process, as well as more details on the application stage.

The connection process involves discussions and agreements between you and your Distribution Network Operator (DNO). Note that the term 'DNO' as used in this guide generally refers to both DNO and IDNO companies. This process is more likely to be successful if you and the DNO can communicate effectively and understand each other's concerns. So, in addition to its main aim of providing a 'route map' of the connection process, the Guide has a number of other aims:

- to provide background information about the GB power sector and the role Distributed Generation has to play;
- to describe the main factors affecting connection costs and ongoing charges;
- to highlight your options relating to your connection works, identify different contracts relating to your connection and discuss some day-to-day operational issues; and
- to describe two key financial incentives for Distributed Generation: Smart Export Guarantee (SEG) and Contracts for Difference (CFD).

What is not covered in the Guide?

In addition to arranging a connection to the network, you will also have other issues to address in order to get your project up and running. These include:

- Designing, installing and operating the generation installation
- Buying and selling electricity (beyond SEGs and CFDs)
- Planning the project
- Financing the project
- Resolving local planning issues

These issues are outside the scope of this Guide, but you will need to know about these in parallel with the connection process.

Note that this document covers the process for connecting generation to the distribution networks in GB. Northern Ireland has different connection arrangements, for example different versions of Engineering Recommendations G98 and G99 are in use. For more information, refer to the Northern Ireland Electricity website: <https://www.nienetworks.co.uk/home>

The format of the guide

This Guide has been written and formatted with you, the reader, in mind. In particular we think this Guide will be useful for customers with generation, installers and developers. We have tried to make this Guide as clear and easy to read as we can, bearing in mind that some of the issues discussed are technical and complex. In particular:

- Terms which may be unfamiliar are defined or explained in boxes around the main text.
- Key points and summaries are highlighted.
- Text is **emboldened** for emphasis.
- Where necessary the Guide distinguishes between the arrangements that apply in Scotland and those which apply in England and Wales. This is indicated with a Scottish flag.
- At the end of most sections there is a pointer on where to find more information.

Though this Guide is intended for the general public and should not require the reader to be technical or familiar with the energy industry, please be aware that the topics covered here are technical and complex. It is therefore necessary to refer to such concepts as voltage and power. Where possible, terms that may be unfamiliar have been explained.

Governance of the guide

This Guide is a Distribution Code Review Panel (DCRP) document. The DCRP will update the Guide using similar processes it has for updating other distribution related documents.

There are many areas of regulation and legislation relating to Distributed Generation which are evolving and a number of issues are under consultation. The Guide has tried to capture the most up to date position at the time of writing. However, for the most up to date information you should refer to key documents and organisation websites. Please see the reference section for more information.

Governance of related codes and documents

Many of the codes and other documents described in this guide are governed in such a way that any interested and materially affected party can propose a change to the codes and documents. This includes the Connection and Use of System charging arrangements (for both distribution and transmission) and the Distribution and Grid Codes. There are also groups with Distributed Generation community and DNO representation where issues can be raised and discussed which may lead to changes being proposed.

The overarching group to discuss commercial and procedural issues associated with connection is the Distributed Energy Resource, [DER Forum](#). Any issues you have for the Group should be raised through trade associations who are represented. Please note that practices between DNOs may be different; for example, where the connection requirements are location specific or the connection risks and the network characteristics are different.

The process of connecting Distributed Generation to the electricity distribution network varies depending on the size of the generation to be connected, and the specific technology to be used. In general, the larger the generation capacity, the more complex the process.

The Engineering Recommendations that cover the connection of Distributed Generation to the electrical distribution network are: EREC G98 (for smaller generation capacities less than 16A per phase) and EREC G99 (for all other projects). These are described further in the information boxes on the following pages.

Previously there were separate versions of the Guides. These have now been combined into this single document which contains information applicable for both G98 and G99 readers. These include:

- EREC G98 compliant units in a single premises;
- EREC G98 compliant units in multiple premises within a close geographic region;
- A guide for EREC G99 Type A Power Generating Module
- A guide for EREC G99 Type B-D Power Generating Modules;

Table 1 includes a quick check for finding the right sections of this guide for you. Read the information boxes for further explanations of terms that may be unfamiliar to you. Where you are installing multiple asynchronous or inverter connected generating units, the application process (ie EREC G98 or G99) is based on the total installed capacity of the generating units. Where you are installing synchronous Power Generating Modules, the application process (ie EREC G98 or G99) is based on the capacity of each generating unit. If you are adding new generating units to an existing installation, refer to the guidance in New and Existing Generation_ Table 2 provides a summary of the relevant chapters for G98 and G99 users. Table 1 Table 3 provides the contents of each chapter section.

Table 1: Table showing the criteria for each EREC.

Sections	Criteria	
Connecting Distributed Generation that falls under EREC G98 in a single premises	Installation of one or more Distributed Generation units at a single premises.	Distributed Generation is compliant with EREC G98 if: <ul style="list-style-type: none"> • It meets the size definition of Micro-generator. • It is installed in accordance with EREC G98. Your installer should be familiar with these requirements; and • It has been tested and approved according to the relevant Type Testing Annex in EREC G98.
Connecting Distributed Generation that falls under EREC G98 in multiple premises	Installation of Distributed Generating units at more than one premises within a close geographic region.	
Connecting Type A Power Generating Modules under EREC G99	Installations where: <ul style="list-style-type: none"> • The registered capacity of each Power Generating Module is >16 A/phase, but less than 1 MW; and • The connection point is below 110 kV (in practice in GB this is at 66 kV or below). 	
Connecting Type B—D Power Generating Modules under EREC G99	Installations where the registered capacity is at or above 1 MW, or for any generation connected at or above 110 kV (in practice in GB this is at 132 kV or above).	

Table 2: Table showing the section relevant to the guides G98 or G99, depending on generator size

Section:	1&2: Power Network Background	3: Connection Process			4: The Connection Application Process			5: Cost of Charges		6: Selling Electricity	7: Technical and Commercial Interfaces			
G98 Single	1 & 2	3.1		3.66	4.1	4.3	4.5	5.1	5.2	5.3	5.5	6.1	6.2	7
G98 Multiple		3.2			3.3									
G99 Type A		3.4		3.5	3.66	4.4		4.6	4.7	5.4	5.5	6.1	6.2	7
G99 Type B-D		3.4				3.5	3.66	4.4		4.6	4.7	5.4	5.5	6.1

Table 3: Table showing the contents of each chapter section and the relevant applicable guide

Section:	Contents:	Applicable for:
1	A Guide to the GB Power Sector	G98 & G99
2	The Role of Distributed Generation	G98 & G99
3.1 – An Overview of Getting Connected	Introduction	G98 Single Premises
	Getting Connected – Main Tasks	
	Getting Connected – IDNO’s Networks	
3.2 – An Overview of Getting Connected	Introduction	G98 Multiple Premises
	Getting Connected – Main Tasks	
	Customer Service and Provision of Information	
3.3 – An Overview of Getting Connected	Introduction	G99 Type A
	Getting Connected – Main Tasks	
3.4 – An Overview of Getting Connected	Introduction	G99 Type B-D
	Connection Process Overview	
	Getting Connected – Project Planning Phase	
	Getting Connected – Information Phase	
	Getting Connected – Design Phase	

Section:	Contents:	Applicable for:
	Getting Connected – Construction Phase	
	Getting Connected – Testing and Commissioning	
	Getting Connected – Ongoing Responsibilities	
	Changes to your Power Generating Module	
	Getting Connected – Medium and Large Stations	
	Getting Connected – IDNO's Networks	
	Where To Find More Information	
<u>3.5 – An Overview of Getting Connected</u>	Types of Power Generating Module	G99 Type A & Type B-D
	New and Existing Generation	
	Customer Service and Provision of Information	
<u>3.6 – An Overview of Getting Connected</u>	Getting Connected – Energy Storage	G98 Single Premises, Multiple Premises, G99 Type A & Type B-D
	Getting Connected – EREC G98 Exceptions	
	Getting Connected – Vehicle to Grid	
	Where to Find More Information	
<u>4.1 Connection Application Process</u>	Introduction	G98 Single Premises
	The Installation Document	
	Other Requirements	
<u>4.2 Connection Application Process</u>	Introduction	G98 Multiple Premises
	The Application for Connection Pro-forma	
	Installation and Commissioning	
	The Installation Document	
	Other Requirements	
<u>4.3 Connection Application Process</u>	Getting Connected – Guidance on Compliance	G98 Single & Multiple Premises
<u>4.4 Connection Application Process</u>	Introduction	G99 Type A
	The Standard Application Form	
	The Connection Offer	
	Connection Conditions	
	Compliance Forms	
	The Installation Document	
	Other Requirements	

Section:	Contents:	Applicable for:
<u>4.5 Connection Application Process</u>	Getting Connected – Guidance on Compliance	G98 Multiple Premises
<u>4.6 Connection Application Process</u>	Introduction	G99 Type B-D
	The Connection Application Timeline	
	Initial Discussions with the DNO	
	Information about the Network	
	The Standard Application Form	
	Network Studies	
	The Connection Offer	
	Wayleaves for New Connections	
	Connection Conditions	
	Interactive Connection Applications	
	Accepting a Connection Offer	
	EREC G99 Additional Forms	
	EREC G99 Notifications	
<u>4.7 Connection Application Process – Generation Licensing</u>	Introduction	G99 Type B-D
	Who Requires a Generation Licence?	
	Requirements for a Generation Licence	
	Applying for a Generation Licence	
	National Grid Interfaces	
	Statement of Works Process	
	Where to Find More Information	
	Getting Connected – Guidance on Compliance	
Reactive Capability across Voltage Range		
<u>5.1 Costs and Charges</u>	Use of System Charges	G98 Single Premises & Multiple Premises
<u>5.2 Costs and Charges</u>	Introduction	G98 Multiple Premises & G99 Type A
	Connection Charges	
	Connection – Other Elements	
	Use of System Charges	G99 Type A

Section:	Contents:	Applicable for:
5.3 Costs and Charges	Metering Requirements, Parties and Charges	
5.4 Costs and Charges	Introduction	G99 Type B-D
	Connection Charges – Other Elements	
	Transmission Connection Charges	
	Where to Find More Information	
	Ongoing Charges - Introduction	
	Generation Distribution Use of System Charges	
	Metering Requirements, Parties and Charges	
	Top-up and Standby Charges	
	Charges Applied by NGESO	
5.5 Costs and Charges	Connection Charges - Infrastructure	G99 Type A & Type B-D
	Changes to Use of System Charges	
6.1 Selling Electricity	Introduction	G98 & G99
	Tariff Structure	
	Eligibility and Accreditation	
	Where to Find More Information	
6.2 Contracts for Difference	Introduction	G99 Type A & Type B-D
	Contracts for Difference (CFD)	
	Renewables Obligation	
	Where to Find More Information	
7 Technical and Commercial Interfaces	Introduction	G99 Type B-D
	Contestable and Non-contestable Work	
	National Electricity Registration Scheme	
	Practicalities of ICP Connections	
	Contracts and Agreements - Introduction	
	Connection Agreements	
	Adoption Agreements	
	Agreements with Other Parties	
	Operational Issues - Introduction	
	Distribution Operating Code	

Section:	Contents:	Applicable for:
	DNO Control Scheme	

Engineering Recommendation G98

EREC G98 is called “Requirements for the connection of Fully Type Tested Micro-generators (up to and including 16 A per phase) in parallel with public Low Voltage Distribution Networks”. It sets out the requirements you must meet before your Micro-generator can be connected to the network. The capacity threshold refers to the **aggregate generating capacity installed in a single premises**. EREC G98 is available on the [Distribution Code website](#).

The document is aimed at the manufacturers and installers of your Micro-generator.

Engineering Recommendation G99

EREC G99 is called “Requirements for the connection of generation equipment in parallel with public distribution networks”. The purpose of the document is to provide guidance to you and to DNOs on all aspects of the connection process. It contains a glossary of items and diagrams of Power Generating Module types and categorisation, which you may find helpful. EREC G99 is available on the [Distribution Code website](#).

Micro-generator

A Micro-generator is defined in EREC G98 as “A source of electrical energy and all associated interface equipment able to be connected to an electric circuit in a Low Voltage electrical installation and designed to operate in parallel with a public Low Voltage Distribution Network with nominal currents up to and including 16A per phase. For the avoidance of doubt this includes electricity storage devices”. 16 A per phase corresponds to 3.68 kW on a single-phase supply and 11.04 kW on a three-phase supply and refers to the aggregate Micro-generator capacity installed in a single premises.

Close Geographic Region

Typically, a Close Geographic Region is one which is fed by the same part of the distribution network, from a single feeder or distribution transformer. Your DNO will be able to advise you as to whether your Micro-generators are within a close geographic region. A general rule of thumb is that if your Micro-generators are within 500 metres of each other, or if the post codes are the same at least up until the last two letters, then they are likely to be within a close geographic region.

Inverters

An inverter is an electrical device that converts Direct Current (DC) to Alternating Current (AC). This is required when you want to connect a generating unit with a DC output (eg. A Photovoltaic array) to the distribution network, which operates at AC. The term Micro-Inverter is used to describe small scale inverters which are connected to (multiple) small generating units, such as individual PV panels. This is often done so that if one panel is impaired for any reason, then the output of the others is not affected.

Type tested equipment

Type Tested equipment is defined in EREC G99 as “A product which has been tested to ensure that the design meets the relevant requirements of this EREC G99, and for which the Manufacturer has declared that all similar products supplied will be constructed to the same standards and will have the same performance”. Examples of products which could be type tested include generating units, inverters and the interface protection. Using type tested equipment simplifies the connection and commissioning process. EREC G98 and G99 annexes contain methodologies for testing equipment against a set of test conditions to demonstrate compliance. The manufacturer produces a Type Test or Compliance Verification Report to demonstrate compliance. Where the whole Micro-generator or Power Generating Module is type tested (rather than just a part), it is Fully Type Tested. All Micro-generators connecting under EREC G98 must be Fully Type Tested. The Fully Type Tested concept also applies in EREC G99. The ENA hosts an online Type Test Verification Report Register. This register is provided to allow anyone access to the Type Test Verification reports for products relating to electricity generation connecting to the DNO networks in the UK. The site also enables product identification and information sharing. You can access the register at: https://www.ena-eng.org/gen-ttr/UserGuide/G98_G99_Guidance_Forms.pdf

The product manufacturer is responsible for uploading and maintaining data and documentation relating to their products. The ENA is carrying out a review of the data that is submitted and raising any queries with manufacturers. Further information about the review can be found at: https://www.ena-eng.org/gen-ttr/UserGuide/G98_G99_Guidance_Forms.pdf

It should be noted that it is the owners of generation equipment who are responsible for procuring and installing compliant equipment.

Cyber Security

The design and operation of your generating unit, the Power Generating Facility and any associated equipment should comply with current cyber security requirements. Documents that you should consider are detailed in EREC G98 and G99 as well as the Reference Section of this Guide.

Equipment Certification

Potential Equipment Certificate providers and manufacturers are investigating formal equipment certification and the ENA are supporting as appropriate.

Emerging Technology

EREC G98 and G99 have a relaxed set of requirements for generation that is classified as an Emerging Technology. This is because the Requirements for Generators (RfG) allows for this. The Emerging Technology status only applies to Type A generation, which has a generating capacity of 0.8 kW to 1 MW and is connected at less than 110 kV (in practice in GB that is 66 kV or below). The Emerging Technologies are:

- Baxi Ecogen' generators (the specific products are the Baxi Ecogen 24/1.0, Baxi Ecogen 24/1.0 LPG and Baxi Ecogen System)
- KD Navien stirling engine m-CHP (Hybrigen SE) (the specific products are the 'NCM- 1130HH – 1 kWel' and the 'NCM-2030HH – 2 kWel')
- Pellematic Smart_e

- Dachs Stirling SE Erdgas and Dachs Stirling SE Flussiggas

RfG Types A to D

The European Requirements for Generators (RfG) Code has introduced the classification of Power Generating Modules by Types. There are four types, A to D, and they relate to the registered capacity and connection voltage of the Power Generating Module. In GB, the Types are:

- Type A: From 0.8 kW to < 1 MW and connected at < 110 kV
- Type B: From 1 MW to < 10 MW and connected at < 110 kV
- Type C: From 10 MW to < 50 MW and connected at < 110 kV
- Type D: \geq 50 MW or connected at \geq 110 kV

Note that in different European countries, the capacity and voltage thresholds may differ.

The technical requirements in RfG are less onerous on the smaller Power Generating Modules, and increase cumulatively for the larger Power Generating Modules, ie a Type B Power Generating Module must meet the requirements for Type A and Type B. Some requirements are common across all European countries. However, some requirements have country-specific parameters, which have been set by national network operators. That means that some of the parameters in GB are different in Northern Ireland, and other European countries.

Current Regulations

Requirements for Generators

The European Third Energy Package was adopted in July 2009 and has been law since March 2011. The Third Energy Package refers to a suite of legislation for both Electricity and Gas. It has three key objectives:

1. Enhancing sustainability and helping the European Union meet its decarbonisation obligations;
2. Ensuring security of supply in light of a changing generation mix; and
3. Creating a single European Market for Electricity.

The Third Energy Package requires the development of European Network Codes. The Network Codes cover three areas: grid connection codes; market codes and system operation codes. One of the Codes is called Requirements for Generators (RfG). This sets out requirements which new generators will need to meet.

The RfG, which became a binding EU regulation in May 2016, is available on the [EUR-Lex website](#). A number of the European Network Codes, including the RfG fall under the category of retained EU law and thus remain applicable to the UK following the UK's withdrawal from the European Union.

A joint Distribution Code Review Panel (DCRP) and Grid Code Review Panel (GCRP) workgroup was charged with implementing the Requirements for Generators in GB. This included setting parameters that the RfG leaves to national interpretation. The workgroup proposed changes to the Grid Code, Distribution Code and supporting Engineering Recommendations. The revised documents were consulted upon with stakeholders by the GCRP and the DCRP.

Drivers for the Requirements for Generators

The EU Network Codes aim to harmonise technical and market rules to help to minimise barriers to energy trading. They also aim to prevent wide-scale technical events, and to help to recover the system if there is such an event in the future. There has been a huge increase in the amount of generation connected to distribution networks – in GB and across Europe. It has been recognised that Distributed Generation can and needs to do more to provide support to the power system, so that generation supports system frequency, remains connected if possible and rides through faults – rather than tripping off, and potentially exacerbating any problems.

The Requirements for Generators contains technical requirements, which have been incorporated into EREC G98 and G99, so that generating units can provide such system support. For example, there are requirements for:

- All Type B, C and D Power Generating Modules to stay connected to the distribution network when there is a fault on the transmission system;
- Type B, C and D inverter connected Power Generating Modules (eg solar PV, battery storage, wind turbines) to provide support in the event of a network fault, using a technique called Fast Fault Current Injection (the design of synchronous machines means they inherently provide support during faults);
- All Power Generating Modules to provide support in the event of a high frequency event (Limited Frequency Sensitive Mode – Over frequency); and
- Type C and D Power Generating Modules to provide support for low frequency events (Limited Frequency Sensitive Mode – Underfrequency).

These requirements have been introduced so that generation of all sizes can help to provide system support. The rules apply to all generation, not just Distributed Generation.

Electricity Storage

The technical and compliance requirements for storage were revised in EREC G98 and G99 to be in line with other generating units and came into effect from September 2022. In the future, there is likely to be a new requirement for Electricity Storage devices operating in import mode to switch to export mode if the grid frequency falls below a defined threshold. The details surrounding these requirements are being considered by an industry working group and are not yet mandatory.

New approach to connections

In response to the need to improve and accelerate customer connections the ENA through their Strategic Connections Group has published the required changes needed to improve connections to the distribution network.

These changes to the connection process are outlined in three priority areas:

- Reforming the distribution network connections queue
- Changing how Transmission & Distribution coordinate connections
- Greater flexibility for storage customers connecting onto the distribution network.

This comes following the announcement of National Grid Electricity System Operator's (NGESO) 5-point plan to improve connection timelines into the transmission system and manage the queue.

More information on the ENAs plans can be found here - <https://www.energynetworks.org/operating-the-networks/connecting-to-the-networks/improving-and-accelerating-customer-connections>

Key terms for EREC G98 and G99

In the process of drafting EREC G98 and G99, the opportunity was taken to align with European terms used (eg from the Requirements for Generators document) and to consolidate terms previously used in GB documents. This means some new terms have been introduced, which are used widely in the documents. The key terms are summarised on this page, and some are explained further in break out boxes throughout the document or in the main text. Terms that are particularly relevant for EREC G98 are indicated with a *.

Table 4: Shows the key terms and their definition

Fully Type Tested*	The whole Micro-generator / Power Generating Module is type tested, rather than just part of the Micro-generator / Power Generating Module.
Micro-generator*	A source of electrical energy and all associated interface equipment connected at Low Voltage to the distribution network, with nominal currents up to and including 16 A per phase.
Micro-generating Plant*	An electrical installation with one or more Micro-generators with nominal currents in sum not exceeding 16 A per phase.
Generating Unit	Any apparatus that produces electricity.
Power Generating Module (PGM)	Either a Synchronous Power Generating Module (SPGM) or a Power Park Module (PPM) - see below.
Synchronous Power Generating Module (SPGM)	An indivisible set of Generating Units—ie one or more units which cannot operate independently of each other—which generate electrical energy in synchronism.
Power Park Module (PPM)	Generating Units that are connected to the network either through power electronics (eg solar PV or electricity storage devices connected through an inverter) or asynchronously (eg some wind turbines are induction or asynchronous generation). They have a single Connection Point to the distribution network.
Power Generating Facility (PGF)	One or more Power Generating Modules connected to at one or more Connection Points. This is a Power Station in EREC G59.
Registered Capacity	The normal full load capacity of a Power Generating Module less the MW consumed when producing the same (ie auxiliary load). For Power Generating Modules connected via an Inverter, the Inverter rating is the Power Generating Module's rating.
Type A / B / C / D	Classifications of Power Generating Modules by size and connection voltage, to determine technical and compliance requirements.

Section 1: A Guide to the GB Power Sector

In this section, the following will be covered:

- An overview of the commercial structure of the power sector
- An introduction to the UK power sector and how it is changing
- A discussion about the various types of organisations that you may come across while developing your Distributed Generation project
- A discussion on Network Innovation projects
- Guidance on where to find more information

Tip: Read the information boxes for definitions or explanations of terms that may be new or unfamiliar.

Introduction

Understanding the UK power sector may be useful when discussing your Distributed Generation project. This section aims to give some background explanation about the UK power sector and how it is changing to meet the challenges of protecting the environment and changing Government policy.

There are many organisations involved in the UK power sector, which are introduced in this section.

Apart from the physical structure of the power sector, there is also a commercial structure, which is discussed in this section.

The Commercial Structure of the Power Sector

The commercial structure of the electricity industry in GB provides a competitive market in electricity retailing. This enables customers to contract with any one of a number of competing electricity suppliers. The sale of energy is also a competitive market. Note, your Feed-In Tariff level is an indication of the minimum you can expect to be paid for the electricity you generate.

Generators sell the electricity that they generate in the wholesale market or directly to suppliers. Suppliers sell the electricity they purchase to customers. The majority of trading occurs in advance of the time of use. The wholesale market is governed by British Electricity Trading Transmission Arrangements (BETTA), which was introduced in 2005.

If you install Distributed Generation, you can use the electricity you produce on site to reduce the amount of electricity that you need to buy thus lowering your electricity bills.

You can also sell electricity to customers, suppliers or, depending on the size of the generation, on the wholesale market. You can read more about power trade options in [Section 6.1 Selling Electricity](#).

The Physical Infrastructure of The Power Sector

The GB power network in the 20th century was primarily based on centralised, fossil-fuel based electricity generation. In the 21st century, there has been a shift towards decentralised, distributed and 'greener' energy source-based generation. This is a shift primarily due to targets set out by the UK government, aiming to achieve net-zero greenhouse gas emissions by 2050. This is because of the 2015 Paris climate change agreement in which governments collectively agreed to reduce global temperature increases to 1.5°C above pre-industrial levels.

Figure 1 below illustrates the infrastructure of the present-day GB power sector.

Figure 1: The current physical infrastructure of the power sector.

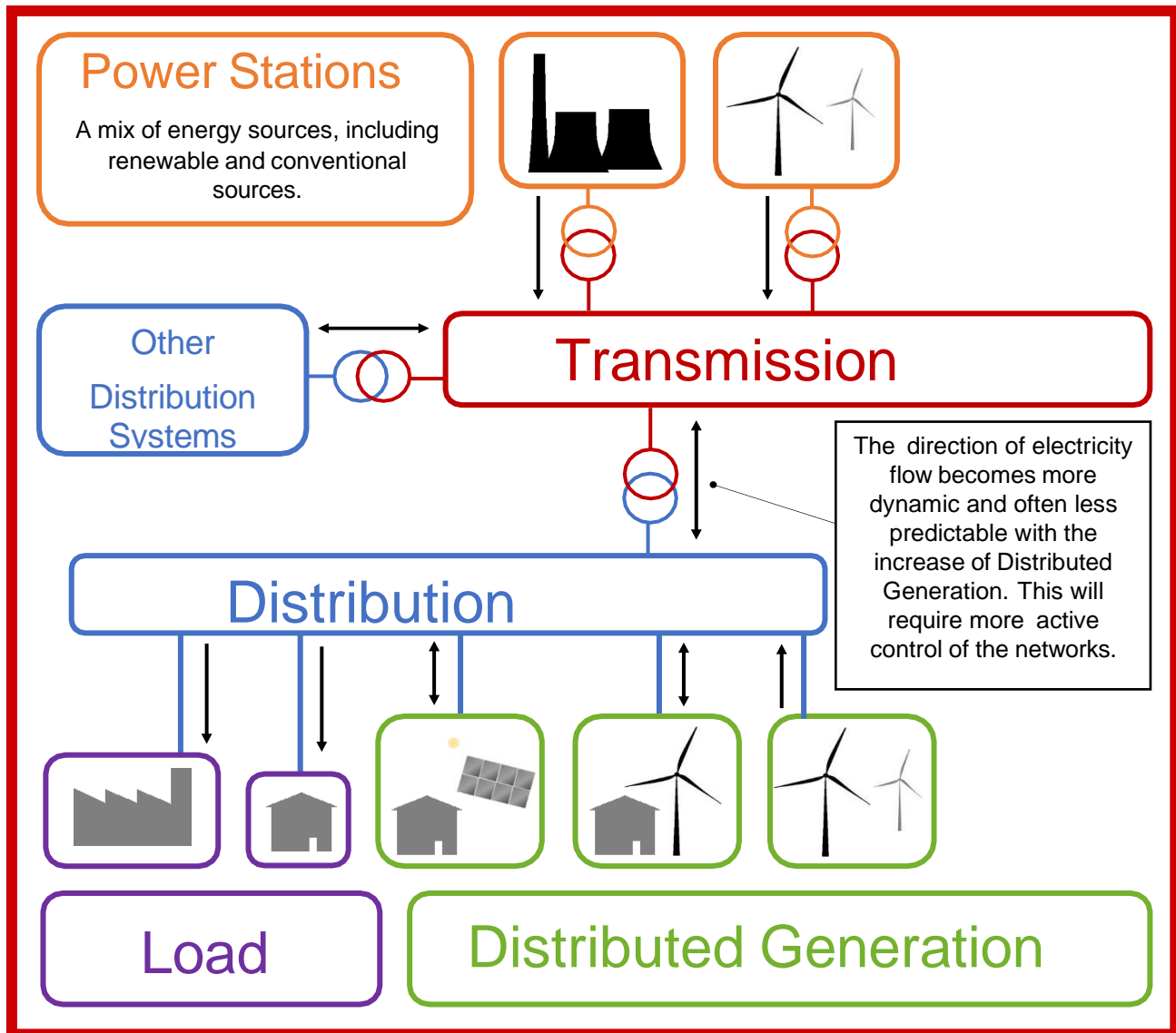

The distribution power network has evolved to include more advanced technologies and sources of generation. Resources connecting to the distribution network are termed Distributed Energy Resources (DERs). These sources impact the traditional flow of power which used to be in one direction and is now bi-directional. The kind of resources that are leading in distribution network penetration are:

- Rooftop Solar Photovoltaic (PV)
- Wind generating units
- Energy storage systems
- New types of demand (heat pumps and electric vehicles)

Key Organisations

The transmission and distribution systems are owned and operated by regulated monopoly businesses. Transmission and distribution businesses recover the costs of operating and maintaining their systems by levying Use of System charges on electricity traded using their network.

Distribution Network Operator (DNO)

A DNO owns, operates and maintains public electricity distribution networks in one or more regions in the UK. They must hold a Distribution Network Operator Licence. Under the terms of their licence, each DNO is allowed to distribute electricity both inside and outside its legacy geographic area.

There are six DNOs in GB. The regions where they operate are shown on the map below.

To facilitate competition in supply, each DNO is required to allow any licensed supplier to use its distribution network to transfer electricity from the transmission system (and from Distributed Generation) to customers. DNOs charge suppliers for using the distribution system.

To develop the future electricity network DNOs are becoming Distribution System Operators (DSO). This will enable them to actively manage their networks and actively engage with customers to realise the benefits that flexible demand, generation and storage can have on distribution networks reducing the need for reinforcement.

DNOs can form part of a group that undertakes other areas of business as well, eg. electricity supply. However, these businesses have to be kept separate, and you, as a developer, will have to interface with the network operator business.

Independent Distribution Network Operators (IDNOs)

An IDNO designs, builds, owns and operates a distribution network, which is an extension of an existing DNO network. They typically build network for new developments such as business parks and residential areas. IDNOs differ from DNOs in that:

- they do not have service areas (they are not tied to a geographical location);
- they are regulated like DNOs, though have fewer licence conditions to meet.

Figure 2: Map showing the electricity distribution.

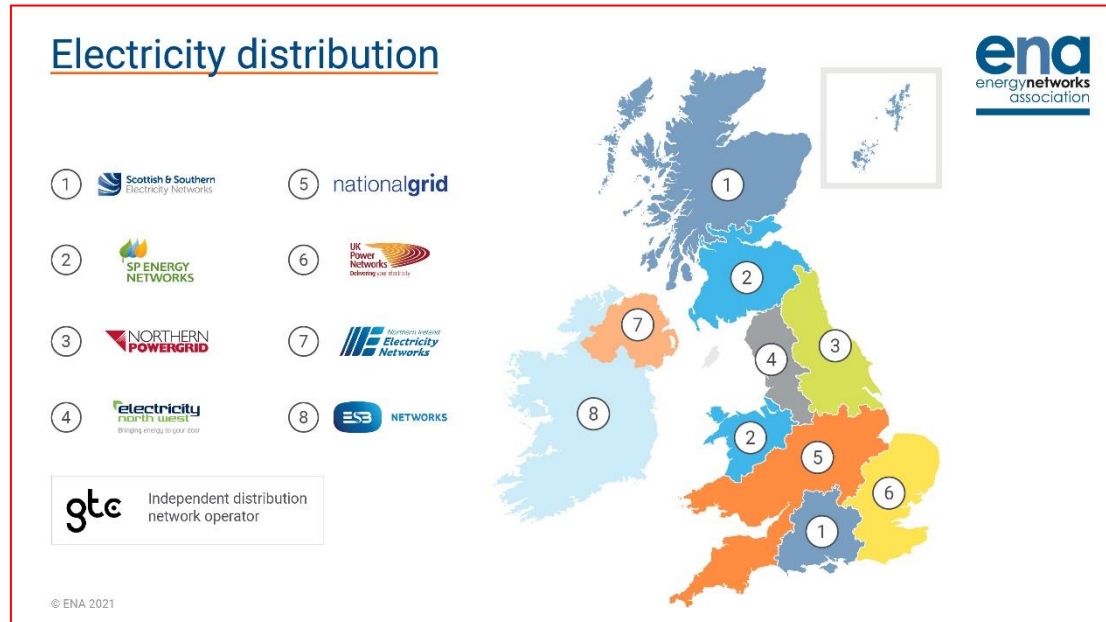

Map of DNO regions in the UK:
For DNO contact details, please see [the membership area](#) for the ENA website. A complete list of DNOs and IDNOs is given on page 33.

If you are connecting your Distributed Generation to an IDNO's network, the process is almost identical to that if you are connecting to a DNO. There are a few exceptions to this, which are discussed in Section 3 of this Guide.

Transmission Owner (TO)

A TO owns and maintains the high voltage transmission system, known as the National Electricity Transmission System, referred to in this Guide as the transmission system. Transmission Owners are responsible for making sure that transmission services are available to the System Operator (see explanation later in this section). The Transmission Owners are as follows:

- National Grid Electricity Transmission (NGET) in England and Wales
- SP Energy Networks (SP Transmission plc) in Central and Southern Scotland
- Scottish and Southern Electricity Transmission (Scottish Hydro Electric Transmission plc) in Northern Scotland

Private Networks

Private networks are extensions of the existing DNO network which are not owned by the DNO itself. The owners of private networks are distinct from an DNO because they do not need to be licenced and are unregulated. For example, private networks can be owned by hospitals, airports, industrial sites, etc. This Guide is not intended to address connections to private networks. If you are connected to a private network, you should discuss your plans with the network owner as soon as possible.

Suppliers

Supply is the retail of electricity. Suppliers buy electricity in bulk from generators, and then sell to consumers. They are responsible for providing bills and customer services, and arranging metering and meter reading. Electricity supply is a competitive market so you can choose and change your electricity supplier.

Aggregators

Aggregators specialise in co-ordinating demand and generation (including storage) to provide demand response and other market services. The Network Operators and Suppliers may buy demand response and other grid balancing services from aggregators.

Energy Service Company (ESCO)

A Government paper defines ESCOs as “a company that provides a customer with energy solutions” rather than simply being an electricity or gas supplier. ESCOs can enter into long-term contracts to provide information, installation, finance, operation and maintenance. There are various models the ESCO can take. ESCOs can work on a performance contract, where they guarantee energy savings and make charges based on the extent to which these savings are achieved. This model is typically used by commercial and industrial customers. ESCOs can also work for communities, servicing a group of customers in the same local area. ESCOs may develop into a household model, to provide energy efficiency savings and small scale generation for home owners, rather than just supplying electricity.

Generators

Generators own, operate and maintain Power Generating Facilities which generate electricity from various energy sources, eg. coal, gas, hydro and nuclear. Newer generation technologies include wind, solar, tidal and wave. See the end of this section for links to more information on generating technologies.

To identify your DNO or IDNO:

If you already have a meter at your site, find the first two digits of your **MPAN** (Meter Point Administration Number), which is shown on your electricity bill, and may be shown on your meter.

This corresponds to your DNO or IDNO, see Table 5Table 5 below.

If you do not have a meter at your site, you can contact the DNO whose geographic area you believe you are in and they will be able to confirm.

Figure 3: showing an example of MPAN, with first two digits indicated

Example MPAN, with first two digits indicated			
S	00	111	222
	13	1234 5678	345

Table 5: Table showing key organisations.

First 2 MPAN digits	Service Area	Distribution Business
10	Eastern England	UK Power Networks– Eastern England
11	East Midlands	National Grid Electricity Distribution (NGED) – East Midlands
12	London	UK Power Networks (UKPN) – London Power Networks (LPN)
13	Cheshire, Merseyside and North Wales	SP Energy Networks – Cheshire, Merseyside and North Wales
14	West Midlands	National Grid Electricity Distribution (NGED) –West Midlands
15	North Eastern England	Northern Powergrid (NPG)
16	North Western England	Electricity North West (ENW)
17	Northern Scotland	SSE Power Distribution – Scottish Hydro Electric Power Distribution
18	Southern Scotland	SP Energy Networks
19	South Eastern England	UK Power Networks (UKPN) – South Eastern Power Networks (SPN)
20	Southern England	SSE Power Distribution – Southern Electric Power Distribution
21	Southern Wales	National Grid Electricity Distribution (NGED) – South Wales
22	South Western England	National Grid Electricity Distribution (NGED) – South West
23	Yorkshire	Northern Powergrid (NPG)
24	No area—IDNO	GTC (Independent Power Networks)
25	No area—IDNO	ESP Electricity Limited
26	No area—IDNO	Last Mile Electricity Limited
27	No area—IDNO	GTC (The Electricity Network Company)
29	No area—IDNO	Harlaxton Energy Networks Limited
30	No area—IDNO	Leep Electricity Network Limited
31	No area—IDNO	UK Power Distribution Limited
32	No area—IDNO	Energy Assets Networks Limited
33	No area—IDNO	Eclipse Power Limited
34	No area—IDNO	Murphy Power Distribution Limited
35	No area—IDNO	Fulcrum Electricity Assets Limited
36	No area—IDNO	Vattenfall Network Limited
17/20	No area—IDNO	Forbury Assets Limited
Tbc.	No area—IDNO	Utility Assets Limited

System Operator (SO)

Electricity cannot be stored at a large scale and so demand has to be balanced with generation on a second-by-second basis by the System Operator. The SO makes requests of generators to increase or decrease output

from their units or may ask some large customers to control their demand. NGENSO is the System Operator in GB. Following a government consultation on greater separation between the System Operator role performed by National Grid and the rest of the National Grid group, National Grid has established a new, legally separate company to carry out the Electricity System Operator function within the National Grid Group, which is called the National Grid Electricity System Operator (NGESO). This separation took place on 1st April 2019.

Balancing Settlement Code company

Elexon is the company that manages the balancing and settlement of electricity trading. They do this by identifying where generators have not generated the amount of electricity they are contracted to produce, and suppliers' customers have not consumed the amount of electricity that was expected. Out of balance parties are charged based on the additional cost to balance supply and demand (often by buying or selling electricity at short notice).

The Balancing and Settlement Code (BSC) governs the operation of this balancing mechanism.

Regulator

The Office of Gas and Electricity Markets (Ofgem) is responsible for:

- regulating prices and performance in the monopoly elements of the electricity supply industry;
- resolving disputes between different parties when necessary; and
- granting licences for the following activities in the power sector:
 - Generation
 - Transmission (and interconnection, a transmission link with another country)
 - Distribution
 - Supply

Generation licence requirements for Distributed Generation are discussed in [Section 4: The Connection Application: Generation Licensing](#).

European organisations

The regulatory arrangements that apply across continental Europe are implemented by National Regulator Authorities (NRA) in each member state of the European Union; Ofgem is the National Regulatory Authority for GB. The regulations are required to comply with policy criteria determined by the European Parliament and implemented through European Directives and Regulations. To assist with this process in relation to electricity networks, a number of bodies have been set up that represent regulators and transmission system operators. National Energy Regulators work with the Agency for the Cooperation of Energy Regulators (ACER) and the Council of European Energy Regulators (CEER) on policy developments in different areas of electricity market liberalisation.

ENTSO-E, the European Network of Transmission System Operators for Electricity, is a membership body for Transmission System Operators (TSO). ENTSO-E promotes cooperation across Europe's TSOs. One of ENTSO-E's roles is drafting the European Network Codes, which includes the Requirements for Generators (RfG).

Following the UK's withdrawal from the European Union the UK is no longer a member of ENTSO-E.

Network Innovation and Industry Developments

Innovation Funding

New challenges and applications in energy networks have motivated many projects that aim to develop innovative tools and products to improve the way networks operate and customers are connected.

Ofgem has a number of mechanisms that the DNOs and other organisations can use to fund electricity network innovation. The two main mechanisms for network companies are called the Network Innovation Allowance (NIA) and Strategic Innovation Fund (SIF), which apply to both electricity and gas distribution and transmission.

- NIA is an allowance each network company receives to fund smaller scale innovation projects which have the potential to deliver benefits to network customers.
- SIF is a competition, where network companies compete for funding for development and demonstration of network innovations such as new technologies or novel operating and commercial arrangements.

Learning from these projects is shared amongst all DNOs and TOs for the benefit of the power sector as a whole. Incorporation of the learning into business-as-usual practices is laid out in the business plans of the individual network companies.

For more information, and details about individual projects, refer to the Smarter Networks Portal, hosted by the Energy Networks Association: <https://smarter.energynetworks.org/>

Electricity Network Innovation Strategy

Following a review of the NIA and SIF, Ofgem proposed a number of changes to the innovation funding schemes. One of these was the requirement on network companies to collaboratively produce an industry wide innovation strategy. The Electricity Network Innovation Strategy sets out a jointly agreed roadmap which demonstrates how innovation can accommodate future whole-system requirements and lead to benefits. The document was first published on 29th March 2018 and a new update on the innovation strategy can be found on the [ENA website](#). The next review will be in 2024. Further information is available on the [ENA website](#).

Transmission and Distribution Interfaces

There has been a significant increase in the amount of connected Distributed Generation in the last few years. This has meant that the DNOs, TOs and the SO have to change the way they work together, to maintain an economic and secure network. In order to address these challenges, the Transmission Distribution Interface (TDI) Steering Group was established by ENA and its members. Network companies recognise the need for distribution and transmission companies to work together more closely in order to consider how they can tackle the whole system impact of Distributed Generation and other technologies such as storage.

ENA Open Networks

In January 2017 the Open Networks Project was launched by the ENA. The aim of the Open Networks Project is to transform the way electricity networks operate and provide the first steps towards creating a smart grid.

One of the focuses on the Open Networks Project is the connection to the distribution network and management of the connection queue, which involved improving the existing interactivity and queue management policy. The Open Networks project consulted on Connection Queue Management in July 2019. A Queue Management User Guide, which builds on the conclusions from the July 2019 and April 2020 consultations is available on the [ENA Website](#). This lays out the previous processes being followed by the network operators, including the interactions with projects that are planning to connect to the distribution network. However, due to the need to accelerate connections to the network to meet key Net Zero targets, NGESO has published their 5-point plan to resolve to improve the connection timelines at transmission level, with a clear focus on adjusting the rules surrounding 'First Come, First Service' approach. In addition, the ENA has published their plans to accelerate customer connections, focusing on 3 priority areas. These are in the discussed in New Approach to Connections in the introduction.

The areas of focus in 2023 are on increasing participation in the local flexibility market in line with actions from the Department for Energy Security and Net Zero (DESNZ). The specific programme work areas are defined below:

1. Network Operation
2. Market Development
3. Planning and Network Development

Network Operation

Efforts are underway to enhance operational planning processes across the transmission and distribution network and promote the efficient coordination and utilisation of flexibility. These include:

- Establishing the rules to manage conflicts in flexibility services between the Electricity System Operator (ESO) and Distribution System Operators (DSOs), allowing providers to enhance their offerings while ensuring network security.
- Developing standards for DSO flexibility market platforms to enable an optimal end-to-end experience for flexibility providers, eliminating the need for multiple interfaces.
- Facilitating real-time data sharing between the ESO, DNOs and other stakeholders. This will enable greater forecasting process and market operations.

Market Development

This area will focus on ensuring that networks deliver open, transparent, accessible, and efficient markets for local flexibility. This includes:

- Improving the Standard Agreement for procuring flexibility services across DSO and ESO. This will help reduce legal costs for flexibility providers.
- Sign-up and pre-qualification processes for flexibility service procurement are being aligned to offer a more user-friendly experience.
- Aligning the definitions of DSO flexibility products to simplify the identification of suitable services for flexibility providers. These efforts aim to streamline the market for local flexibility, benefiting both providers and consumers.

Planning and Network Development

The electricity distribution sector is undergoing significant initiatives to improve and optimise network forecasting and planning processes whilst ensuring the visibility of upcoming and future flexibility requirements. This includes:

- Achieving common methods for carbon reporting to standardise measurements and reporting of carbon emissions which provides customers with visibility of local flexibility market carbon intensity across GB.
- Reviewing and updating the Network Development Plan (NDP) and the Whole System Coordination Register Form to provide stakeholders with insights into major network developments.
- Streamlining the connection process for DERs and improving network visibility.

New technologies

From April 1 2023 the new approach to connections requires DNOs to offer Curtailable Connections with non firm access arrangements to enable generation to be connected to the network more quickly. This builds on the use of Active Network Management (ANM) schemes, which were trialed in innovation projects and have recently been included as part of Business-as-Usual Connection Offers. ANM uses control systems to manage Distributed Generation in constrained areas. Note that ANM connections may only be available in selected parts of the network. Export limiting devices are also coming into use. These devices allow a limit to be set above which the generation will not export. This may allow generation to have a constrained connection, to reduce the need for reinforcement. If you want to explore the use of these devices, seek guidance from your DNO. ENA has published Engineering Recommendation (EREC) G100, which provides technical guidance on the connection of Customer Export Limiting Schemes that operate in parallel with the distribution systems of licensed DNOs. This is available at: [ENA G100 Requirements](#).

Energy storage is becoming increasingly prevalent in distribution networks. For more information on network connected storage (eg. batteries), refer to [Section 3: Getting Connected—Energy Storage](#).

Where to Find More Information

There are some very good guides to the UK power sector available in the public domain. In particular, if you want to read more on this subject, you may wish to read the following:

- [A Guide: Sale of Power Opportunities for Distributed Generators](#); DTI (Department for Trade and Industry);
- Guidance Note – The Electricity Trading Arrangements: A beginner’s guide; Elexon <https://www.elexon.co.uk/knowledgebase/about-the-bsc/>

A good source of information on the organisations we have introduced are their own websites:

- [A Guide: Sale of Power Opportunities for Distributed Generators](#); DTI (Department for Trade and Industry);
- Guidance Note – The Electricity Trading Arrangements: A beginner’s guide; Elexon <https://www.elexon.co.uk/knowledgebase/about-the-bsc/>

A good source of information on the organisations we have introduced are their own websites:

- Energy Networks Association —the industry body for UK energy transmission and distribution licence holders and operators: www.energynetworks.org
- A list of IDNOs can be found on the Ofgem website: <https://www.ofgem.gov.uk/publications/list-all-electricity-licensees-including-suppliers>
- Ofgem—The Regulator: <https://www.ofgem.gov.uk/>
- National Grid —The GB Electricity System Operator, and Transmission Owner in England and Wales: <https://www.nationalgrid.com/electricity-transmission/>
- Elexon—The Balancing and Settlement Code Company: <https://www.elexon.co.uk/>

For more information on ESCOs, the following document is a useful reference:

- Making ESCOs Work: Guidance and Advice on Setting Up and Delivering an ESCO; London Energy Partnership, which is on the London Energy Partnership website: <https://khub.net/>

The following website gives more information on generation technologies:

- Energy Saving Trust: <https://energysavingtrust.org.uk/>

The GB Distribution Code, Annex 1 and Annex 2 documents and the associated GB Distribution Code User Guide can be found in the link below:

- DCode: <https://dcode.org.uk/>

The GB Grid Code and the associated Guide can be found in the link below:

- GCode: <https://www.nationalgrideso.com/>

Information about licence exceptions and private networks can be found:

- UK legislation: <https://www.legislation.gov.uk/uksi/2001/3270/contents/made>

Section 2: The Role of Distributed Generation

In this section, the following will be covered:

- An introduction to the role of Distributed Generation
- A discussion on the drivers for Distributed Generation
- Some of the benefits and impacts of Distributed Generation
- References to some documents where you can find out more on these issues

Introduction

DERs are distributed energy resources that are interconnected to the grid near sites of electricity consumption, such as roof-top solar and battery storage systems. The increased expansion of the distribution network is transforming the way electricity is generated, delivered, consumed, managed, and traded.

DERs pose challenges on the current grid infrastructure which was previously designed for traditional flow of power in one direction, however these challenges present many opportunities for investments, planning and technological growth and development for all parties involved (network operators, stakeholders, and customers).

The benefits of DERs are not only limited to the customer, but also to network operators by providing ancillary services to help maintain grid stability and reliability.

With appropriate technological advancements, policies, and standardised regulations, DERs can provide increased value to the power network and improve system reliability whilst reducing overall energy costs.

What is driving Distributed Generation

Environmental concerns

Globally there has been increasing concern over greenhouse gas emissions and the impact that they may be having on the environment. Most of the electricity in the UK has traditionally been generated by power stations fuelled by fossil fuels, for example coal, gas and oil. The burning of these fuels makes a significant contribution to greenhouse gas emissions. There is therefore a drive to change the mix of generation technologies we have, to include more low-carbon options.

Technological innovation

Technology is developing all the time, and due to drivers, such as environmental concerns and government policy, there are more generating technologies available now than there were when the national grid was being developed. For example, wind, wave, solar and biomass generation. Although the connection and integration of these newer generating technologies may pose challenges, innovative technical solutions are being sought to overcome these challenges.

Government policy

The Department of Energy Security and Net Zero (DESNZ) oversees energy policy and climate change mitigation policy. The UK energy supply is one of DESNZ's key policy areas. DESNZ is developing policy to ensure that in the UK energy supplies are secure, low carbon, and fuelled from a diverse mix of energy supplies. However, DESNZ also has to ensure that energy prices are maintained at affordable levels. Relevant pieces of legislation include:

- Climate Change Act 2008
- Energy Act 2008

- Energy Bill

The Climate Change Act sets out legally binding targets for emissions reductions. As such, policy has been developed, which introduces initiatives such as:

- Climate Change Agreement (Climate Change Levy)
- Zero Carbon Homes

As well as legislation from the UK Government, the EU also introduced relevant legislation and initiatives, such as the EU Emissions Trading System and the European Third Package, which has resulted in set of European Network Codes. A number of the European Network Codes, including the Requirements for Generators fall under the category of retained EU law and thus remain applicable to the UK following the UKs withdrawal from the European Union.

Security of supply

The UK increasingly relies on importing fuel, in the form of gas, coal and oil. This introduces a great deal of uncertainty as the cost and reliability of supply is outside of UK control. It is therefore an advantage to have a diverse mix of energy sources, which would make the UK less vulnerable to a restriction in fuel availability or rise in price.

It is also known that fossil fuels will eventually run out as they are being used much faster than they are being created. As they become scarcer, the prices will rise as the markets become more competitive. Therefore, to ensure the security of the energy supply into the future, alternative sources are being encouraged.

Benefits of Distributed Generation

There are a number of benefits that increased Distributed Generation has for the UK and its electricity system. These include:

- **Increased energy mix** —Distributed Generation is often a renewable source of energy, such as solar, wind or biomass, or uses the energy in a more efficient way as with Combined Heat and Power (CHP) projects. Therefore increased Distributed Generation results in a lower carbon mix of energy sources in the electricity system.
- If Distributed Generation is connected close to the point of use, there is a **reduced need for the distribution and transmission infrastructure**. In some cases, this can delay the need for reinforcement, although the TO and the DNO also need to ensure that the network provides adequate security of supply for its users.
- Where there is a balance between Distributed Generation and local demand the **transmission and distribution losses are reduced**, when compared with the alternative of the centralised power stations and bulk transmission of electricity.
- The introduction of local generation in businesses and communities can lead to **greater awareness of energy issues**.

There are a variety of commercial benefits to having Distributed Generation, which include:

- **Self-Consumption**, where you use the electricity that you generate to avoid importing from the grid, therefore lowering your electricity bills.
- **Selling electricity** that you generate, including gaining Smart Export Guarantee (SEG) payments and Contracts for Difference (CFD). This is discussed further in [Section 6: Selling Electricity](#).
- Climate Change **Levy Exemption Certificates (LECs)** are issued to generators of renewable energy and good quality Combined Heat and Power (CHP). These can be sold to the supplier along with the energy generated. Companies can use LECs to avoid paying the Climate Change Levy tax.
- **Embedded benefits** of the generating unit being connected to the distribution rather than the transmission network, eg. charge avoidance of Transmission Network Use of System charges and

Balancing Services Use of System charges. Embedded benefits are changing, see Section [5.3](#), [5.4](#) and [5.5](#).

- Generators whose equipment has a capacity greater than 3 MW (and/or the ability to deliver in excess of +/- 15 MVar of reactive power) can enter into agreements with NGENSO to provide **Ancillary Services**, for which they will be paid.
- Generation that is not receiving low carbon support (e.g. Feed-in Tariffs, Renewables Obligation) and does not have a long-term contract to provide Short Term Operating Reserves (STOR) to National Grid Electricity Transmission could be eligible to enter the **Capacity Market** and receive payments for delivering energy at times of system stress.
- **EU Emissions Trading System (ETS)** - applies to approximately 10,000 energy intensive users in the UK such as metal industry, paper factories and refineries. These large energy users have been allocated green-house gas allowances for their operations. At the end of each year, they must ensure they have enough allowances to cover their emissions: they can buy additional allowances or sell any surplus allowances generated from reducing

Impacts of Distributed Generation

As well as introducing benefits, the increased penetration of Distributed Generation in UK distribution networks also poses challenges. These will depend on a variety of factors, such as the generation technology, the voltage level the Distributed Generation is connected to, the size of the generating unit(s), the level of export to the distribution system, and on the type of network (e.g. urban or rural).

Some examples of the challenges posed to distribution networks by Distributed Generation include:

- Distributed Generation changes the current flows and shape of the load cycle where they are connected. This could cause:
 - Thermal ratings to be exceeded.
 - **System voltage to rise** beyond the acceptable limits.
 - **Reverse power flows**, i.e. power flows in the opposite direction to which the system has been designed.
- Distributed Generation can contribute to **fault level**, which can raise the fault level above the rating of network equipment.
- There are a number of **power quality** limits that can be affected by Distributed Generation, including:
 - **Contributions to harmonics**, particularly if a significant number of inverter controllers are present.
 - **Voltage unbalance** which affects power quality, if there are lots of single-phase generating units.
 - **Voltage fluctuation or flicker**, if the output of the Distributed Generation changes rapidly.

Note: The technical terms used above are defined in the glossary.

Where to Find More Information

The amount of generation connected to distribution networks has increased significantly since 2010. Today there is over 27,000 MW of Distributed Generation in the UK. The benefits and challenges of Distributed Generation are complex, and the industry's understanding of them is evolving as experience increases. For more information on current initiatives in distribution networks, the following documents are useful:

- [The Electricity Networks Innovation Strategy; Energy Networks Association; 2022](#)
- [The Open Networks project](#); Energy Networks Association

The following documents are useful if you want more information on Government policy:

- [The Clean Growth Strategy](#); BEIS & DESNZ; 2017 – last updated 2018
- [Transitioning to a net zero energy system; smart systems & flexibility plan](#); BEIS & DESNZ; 2021

For the most up to date information on relevant Government policy, refer to the DESNZ website:

[Department for Energy Security and Net Zero - GOV.UK \(www.gov.uk\)](https://www.gov.uk)

For more information on Embedded Benefits:

- [Embedded Generation and Embedded Benefits](#); Elexon; March 2019
- For the latest developments on Embedded Benefits visit the [Ofgem Targeted Charging Review \(TCR\) webpage](#) and the [charging future's forum website](#)

Section 3: Distribution Generation Connection Process

This flowchart guides you to the most relevant Connection Guide for the Distributed Generation you are planning to install. The table below the flowchart indicates the chapter sections in this document that are relevant to your installation based on the type of Guide you are looking for.

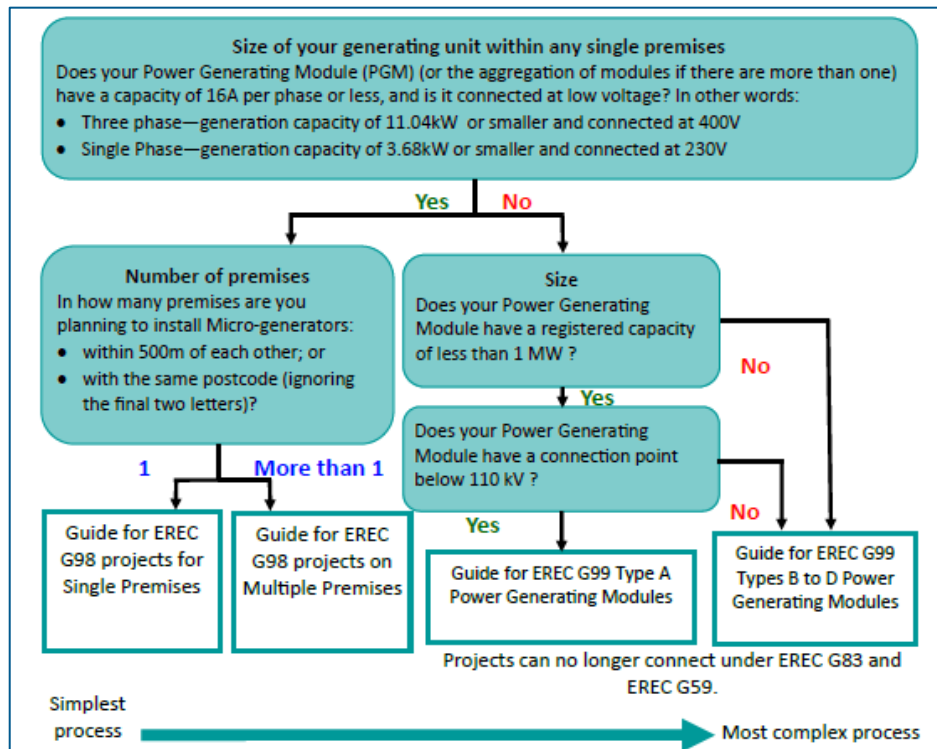

Figure 4: Flowchart indicating the relevant guide based on installation type.

Table 6: Table showing the section relevant to the guides G98 or G99, depending on generator size

Section:	1&2: Power Network Background	3: Connection Process			4: The Connection Application Process			5: Cost of Charges		6: Selling Electricity	7: Technical and Commercial Interfaces
G98 Single	1 & 2	3.1		3.6	4.1	4.3	4.5	5.1		6.1	6.2
G98 Multiple		3.2			4.2			5.2			
G99 Type A		3.3	3.5	4.4	5.3	5.5					
G99 Type B-D		3.4		4.6		4.7	5.4	7			

Table 7: Table showing the contents of each chapter section and the relevant applicable guide

Section:	Contents:	Applicable for:
1	A Guide to the GB Power Sector	G98 & G99
2	The Role of Distributed Generation	G98 & G99
3.1 – An Overview of Getting Connected	Introduction	G98 Single Premises
	Getting Connected – Main Tasks	
	Getting Connected – IDNO’s Networks	
3.2 – An Overview of Getting Connected	Introduction	G98 Multiple Premises
	Getting Connected – Main Tasks	
	Customer Service and Provision of Information	
3.3 – An Overview of Getting Connected	Introduction	G99 Type A
	Getting Connected – Main Tasks	
3.4 – An Overview of Getting Connected	Introduction	G99 Type B-D
	Connection Process Overview	
	Getting Connected – Project Planning Phase	
	Getting Connected – Information Phase	
	Getting Connected – Design Phase	

Section:	Contents:	Applicable for:
	Getting Connected – Construction Phase	
	Getting Connected – Testing and Commissioning	
	Getting Connected – Ongoing Responsibilities	
	Changes to your Power Generating Module	
	Getting Connected – Medium and Large Stations	
	Getting Connected – IDNO's Networks	
	Where To Find More Information	
<u>3.5 – An Overview of Getting Connected</u>	Types of Power Generating Module	G99 Type A & Type B-D
	New and Existing Generation	
	Customer Service and Provision of Information	
<u>3.6 – An Overview of Getting Connected</u>	Getting Connected – Energy Storage	G98 Single Premises, Multiple Premises, G99 Type A & Type B-D
	Getting Connected – EREC G98 Exceptions	
	Getting Connected – Vehicle to Grid	
	Where to Find More Information	
<u>4.1 Connection Application Process</u>	Introduction	G98 Single Premises
	The Installation Document	
	Other Requirements	
<u>4.2 Connection Application Process</u>	Introduction	G98 Multiple Premises
	The Application for Connection Pro-forma	
	Installation and Commissioning	
	The Installation Document	
	Other Requirements	
<u>4.3 Connection Application Process</u>	Getting Connected – Guidance on Compliance	G98 Single & Multiple Premises
<u>4.4 Connection Application Process</u>	Introduction	G99 Type A
	The Standard Application Form	
	The Connection Offer	
	Connection Conditions	
	Compliance Forms	
	The Installation Document	
	Other Requirements	

Section:	Contents:	Applicable for:
<u>4.5 Connection Application Process</u>	Getting Connected – Guidance on Compliance	G98 Multiple Premises
<u>4.6 Connection Application Process</u>	Introduction	G99 Type B-D
	The Connection Application Timeline	
	Initial Discussions with the DNO	
	Information about the Network	
	The Standard Application Form	
	Network Studies	
	The Connection Offer	
	Wayleaves for New Connections	
	Connection Conditions	
	Interactive Connection Applications	
	Accepting a Connection Offer	
	EREC G99 Additional Forms	
	EREC G99 Notifications	
<u>4.7 Connection Application Process – Generation Licensing</u>	Introduction	G99 Type B-D
	Who Requires a Generation Licence?	
	Requirements for a Generation Licence	
	Applying for a Generation Licence	
	National Grid Interfaces	
	Statement of Works Process	
	Where to Find More Information	
	Getting Connected – Guidance on Compliance	
Reactive Capability across Voltage Range		
<u>5.1 Costs and Charges</u>	Use of System Charges	G98 Single Premises & Multiple Premises
<u>5.2 Costs and Charges</u>	Introduction	G98 Multiple Premises & G99 Type A
	Connection Charges	
	Connection – Other Elements	
	Use of System Charges	G99 Type A

Section 3.: Distribution Generation Connection Process

Section:	Contents:	Applicable for:
5.3 Costs and Charges	Metering Requirements, Parties and Charges	
5.4 Costs and Charges	Introduction	G99 Type B-D
	Connection Charges – Other Elements	
	Transmission Connection Charges	
	Where to Find More Information	
	Ongoing Charges - Introduction	
	Generation Distribution Use of System Charges	
	Metering Requirements, Parties and Charges	
	Top-up and Standby Charges	
	Charges Applied by NGESO	
5.5 Costs and Charges	Connection Charges - Infrastructure	G99 Type A & Type B-D
	Changes to Use of System Charges	
6.1 Selling Electricity	Introduction	G98 & G99
	Tariff Structure	
	Eligibility and Accreditation	
	Where to Find More Information	
6.2 Contracts for Difference	Introduction	G99 Type A & Type B-D
	Contracts for Difference (CFD)	
	Renewables Obligation	
	Where to Find More Information	
7 Technical and Commercial Interfaces	Introduction	G99 Type B-D
	Contestable and Non-contestable Work	
	National Electricity Registration Scheme	
	Practicalities of ICP Connections	
	Contracts and Agreements - Introduction	
	Connection Agreements	
	Adoption Agreements	
	Agreements with Other Parties	
	Operational Issues - Introduction	
	Distribution Operating Code	

Section:	Contents:	Applicable for:
	DNO Control Scheme	

Section 3.1: G98 Single Premises, An Overview of Getting Connected

In this section:

- An introduction to getting connected
- The main tasks in the process of connecting one or more units within a single customer's installation, and who can help you
- Guidance on where to find more information

Introduction

In most cases, the installation of small generating units into a single premises will have very little effect on the network. Therefore, the connection process is relatively simple, and can be summarised as “fit and inform”. The diagram opposite presents the key actions that you must complete to connect one or more units of small-scale generation in a single premises. These tasks are based on the requirements set out in EREC G98 and are described in more detail in this section.

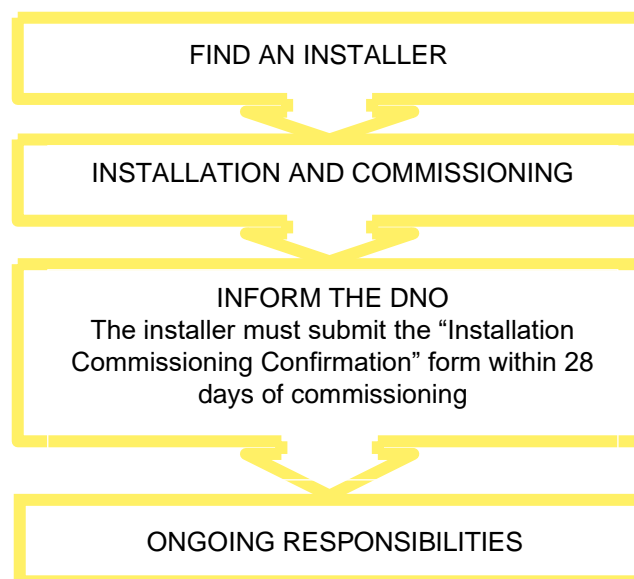

Figure 5: Presenting the key actions to complete to connect one or more units of small-scale generation in a single premise

Note that this document covers the process for connecting generation to the distribution networks in GB. Northern Ireland has different connection arrangements, for example different versions of Engineering Recommendations G98 and G99 are in use. See www.nie.co.uk.

Getting Connected – Main Tasks

Finding an installer

The first task is to find a competent installer, who is using type tested equipment (see note in “Is this the right Guide for my project?”). Installation must be carried out by installers who are competent and have sufficient skills and training to apply safe methods of work to install a generating unit in compliance with EREC G98. This includes having recognised and approved qualifications relating to the primary energy source and general

electrical installations. There are companies who design, install and commission domestic generation. They can fully certify and sign off installations. Certified generation products and installers can be found on the following website: <https://mcscertified.com/>

The Microgeneration Certification Scheme is operated by the [MCS Service Company](#). Your installer must be certified for you to claim Smart Export Guarantees. There is more information about this in [Section 6: Selling Electricity - Smart Export Guarantee](#).

All Micro-generators connecting under EREC G98 must be Fully Type Tested. This is where the whole Micro-generator is type tested, rather than just part of the Micro-generator.

Installation and Commissioning

Your installer should be aware of the requirements to ensure that installation and commissioning is in line with EREC G98. This includes ensuring that the installation complies with the wiring regulations (BS 7671) and is correctly earthed. Your installer must also ensure, among other things, that:

- No modifications should be made to the equipment;
- Appropriate safety labelling is provided;
- The generating unit will disconnect from the distribution network if your mains power is interrupted; and
- The generating unit is installed in accordance with the manufacturer's instructions.

During the commissioning, your installer will check that your equipment is working as it should.

Informing the DNO

Once your installation and commissioning is complete, the DNO needs to be made aware of your generating unit(s). This is so that the DNO can take this into account when operating and designing the network. Your installer must notify the DNO within 28 days of commissioning the generating unit and provide them with information on the installation. This is a legal requirement.

The information is captured on an "installation commissioning confirmation" form, which is given in the ["Installation Document"](#), which is Form B in Appendix 3 of EREC G98. These are available on the Energy Networks Association website.

Note: DNOs may have their own installation commissioning confirmation forms on their websites.

Ongoing responsibilities

Although the focus of this Guide is to inform you about the process of connecting your generation to the distribution network, you should be aware that once it is connected you have some responsibilities. These include:

- The responsibility to keep it maintained by someone who is competent to do so;
- Notify your DNO of any operational incidents or failures that affect your compliance with EREC G98; and
- Inform your DNO if you remove or replace your generating unit.

Getting Connected – IDNO's Networks

The process for connecting your Distributed Generation to an IDNO's network follows EREC G98 or G99 and is therefore similar to connecting to a DNO's network. IDNOs are licensed entities and are bound by some of the same licence conditions as DNOs, including certain performance standards such as timescales for responding to requests for quotes. The majority of what is included in this guide applies to both DNO and IDNO connections.

However, there are a few key differences for a Distributed Generation connection to an IDNO network. The most significant of these is that the IDNO has a relationship with their DNO. This relationship will not involve

you directly but may restrict what the IDNO can readily allow to connect to their network. This is not likely to affect a generation project that is compliant with EREC G98.

To determine whether you are connected to a DNO or IDNO network, refer to Table 5. Table 5.

Section 3.2: G98 Multiple Premises, An Overview of Getting Connected

In this section:

- An introduction to getting connected
- The main tasks in the process of connecting small generating units in multiple premises
- Customer service and provision of information

Introduction

While the process for connecting small-scale generation in a single premises is relatively simple, the process for connecting small-scale generation in multiple premises is more involved. Projects involving multiple installations could be, for example:

- A housing refurbishment programme in the same road or street
- A new housing development

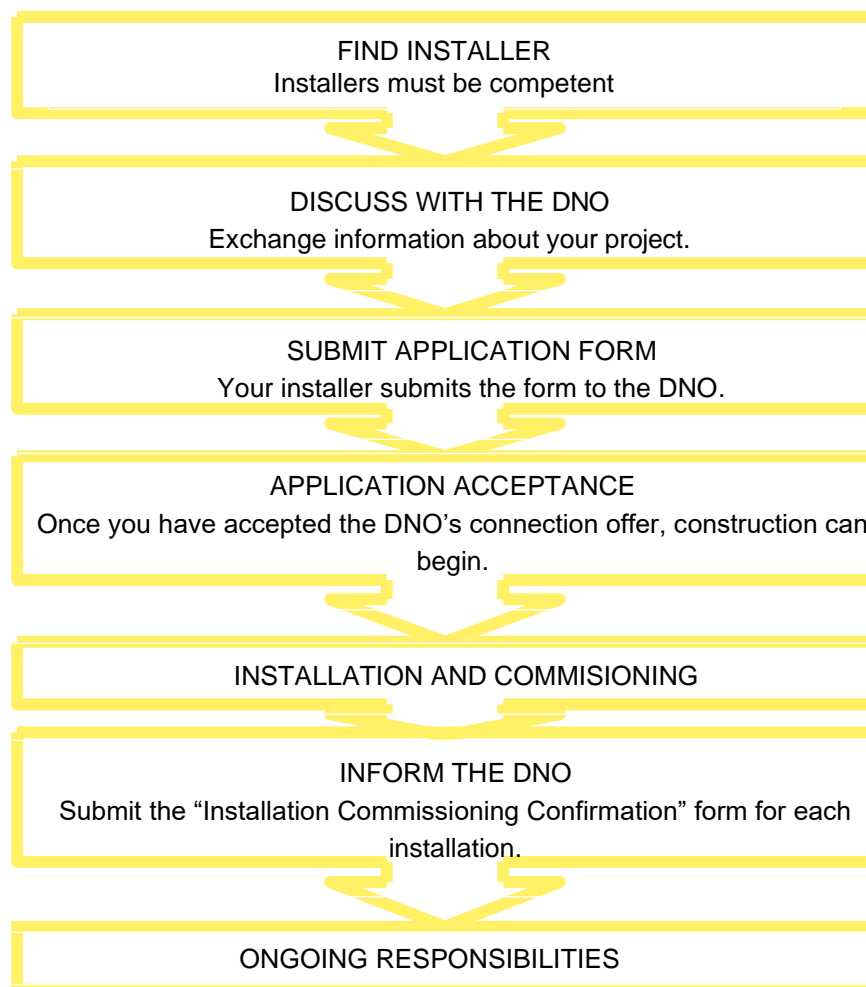

Figure 6: Presents the key actions you need to complete to connect multiple units of small-scale generation within different customers sites in close geographic region.

There is a key difference between connecting units at one customer site and multiple units within different customer sites within a close geographic region: for multiple **sites you need to get approval from the Distribution Network Operator (DNO)** before you can connect.

Figure 6: Presents the key actions you need to complete to connect multiple units of small-scale generation within different customer sites in close geographic region. Figure 6 above presents the key actions that you have to complete to connect multiple units of small-scale generation within different customer sites and in a close geographic region. These tasks are based on the requirements set out in EREC G98 and are described further in this section.

Note that this document covers the process for connecting generation to the distribution networks in GB. Northern Ireland has different connection arrangements, for example different versions of Engineering Recommendations G98 and G99 are in use. See www.nie.co.uk.

Getting Connected – Main Tasks

Finding an installer

The first task is to find a competent installer, who is using type tested equipment (see note in “Is this the right Guide for my project?”). Installation must be carried out by installers who are competent and have sufficient skills and training to apply safe methods of work to install a generating unit in compliance with EREC G98. This includes having recognised and approved qualifications relating to the primary energy source and general electrical installations. There are companies who design, install and commission domestic generation. They can fully certify and sign off installations. Certified generation products and installers can be found on the following website: <https://mcscertified.com/>

The Microgeneration Certification Scheme is operated by the MCS Service Company. Your installer must be certified in order for you to claim Smart Export Guarantees. There is more information about this in [Section 6: Selling Electricity - Smart Export Guarantee](#).

All Micro-generators connecting under EREC G98 must be Fully Type Tested. This is where the whole Micro-generator is type tested, rather than just part of the Micro-generator.

Discussions with the DNO

You must discuss your plans with the DNO before starting work. You should do this as soon as possible in your planning, as the DNO’s response may have a big impact on how you plan your project. You may discuss the feasibility of your connection, and if there will be any charges for connection (charges are discussed further in [Section 5: Costs and Charges](#)).

If your generation project is part of a larger project, eg. developing new housing, then your application needs to be co-ordinated with the connection application for the import supplies themselves. The DNO will need to take into account the new generation in the design of the overall connection.

All DNOs provide information to support generation developers, such as capacity heat maps, on their websites. These can be an important source of information. In addition, there may be dedicated generation ‘surgeries’ or ‘drop in’ sessions to discuss your project with the DNO.

Submitting an application form

Once you have planned the project and exchanged information about your plans with the DNO, it is time to submit an application form. The format of the application form is given in Form A in Appendix 3 of EREC G98, which is available at [Energy Network Association’s website](#). Your installer should submit the application form on your behalf.

Application acceptance

When you submit your application form you need to include technical details of the equipment. The DNO needs this information to assess the impact that your generating equipment may have on the network.

Once the DNO has conducted these assessments, they will produce a connection offer. This will specify the conditions for your connection and inform you of any connection charge that you may be asked to pay (charges are discussed further in [Section 5: Costs and Charges](#)). You should ensure that you fully understand this offer before accepting it. You should discuss questions with your DNO if you are unsure.

Installation and Commissioning

Your installer should be aware of the requirements to ensure that installation and commissioning is in line with EREC G98. This includes ensuring that the installation complies with the wiring regulations (BS 7671) and is correctly earthed. Your installer must also ensure, among other things, that:

- No modifications should be made to the equipment;
- Appropriate safety labelling is provided;
- The generating unit will disconnect from the distribution network if your mains power is interrupted; and
- The generating unit is installed in accordance with the manufacturer's instructions.

During the commissioning, your installer will check that your equipment is working as it should.

Informing the DNO

Once your installation and commissioning are complete, the DNO needs to be made aware of your generating unit(s). This is so that the DNO can take this into account when operating and designing the network.

Your installer must notify the DNO within 28 days of commissioning the generating units in each premise and provide them with information on the installation. The content and format of the installation commissioning confirmation is set out in the "[Installation Document](#)", which is Form B in Appendix 3 of EREC G98. These are available on the [Energy Networks Association website](#).

Note: DNOs may have their own installation commissioning confirmation forms on their websites — a web search should help you locate the forms you need or try telephoning your DNO.

Ongoing responsibilities

Although the focus of this Guide is to inform you about the process of connecting your generation to the distribution network, you (or the owner of the equipment if that is not you) should be aware that once it is connected you have some responsibilities. These include:

- The responsibility to keep it maintained by someone who is competent to do so;
- Notify your DNO of any operational incidents or failures that affect your compliance with EREC G98; and
- Inform your DNO if you remove or replace your generating unit.

Getting Connected – IDNO's Networks

The process for connecting your Distributed Generation to an IDNO's network follows EREC G98 or G99, and is therefore similar to connecting to a DNO's network. IDNOs are licensed entities and are bound by some of the same licence conditions as DNOs, including certain performance standards such as timescales for responding to requests for quotes. The majority of what is included in this guide applies to both DNO and IDNO connections. However, there are a few key differences for a Distributed Generation connection to an IDNO network:

- Provision of Information: IDNOs have a reduced set of licence conditions compared with DNOs, and they are not obliged to provide the same documents for customers. IDNOs are not required to produce Long Term Development Statements nor Connection Charging methodologies and statements.
- Interaction between the IDNO and the Host Network: When an IDNO receives an application for connection for Distributed Generation, they design and build the network infrastructure and connect to the host network, which could be a DNO or IDNO. If your generation project would cause certain network parameters to exceed defined limits, such as voltage or export to the host network, the IDNO and host network will explore options for accommodating your project. This discussion will take place between the IDNO and the host network, and will not involve you directly. However, the IDNO may then discuss different options with you for the most appropriate generation project to be connected.
- Formal Agreements: IDNOs will not necessarily insist on the same set of formal agreements that the DNOs will. Agreements such as the connection and adoption agreements may not be required.

To determine whether you are connected to a DNO or IDNO network, refer to [Table 5](#)

Customer Service and Provision of Information

There are a number of drivers for DNOs to provide a good level of service to customers, including:

- The current price control proposals;
- Standards of Performance; and
- Ofgem DER forums.

Price Control Proposals (RIIO-ED2)

Ofgem administers a price control regime which allows DNOs to earn a fair rate of return while limiting costs passed on to customers. The current price control period is called RIIO-ED2, which runs until 2028. The RIIO-ED2 rules include a number of mechanisms to incentivise DNOs to provide a good service to Distributed Generation customers. The latest information is provided on [Ofgem's website](#).

DNOs publish annual [ICE plans for stakeholder engagement](#).

Guaranteed Standards of Performance

The guaranteed standards of Performance are set out in Standard Licence Condition 15A. They include, for example, maximum timescales in which DNOs must provide you with a quotation (Connection Offer). Ofgem has guidance documents about these Standards on their [website](#).

DER Forum

The DER Forums, hosted by the ENA on behalf of DNOs, are events that are used to explore issues and concerns around Distributed Generation connections, including barriers to Distributed Generation and process issues. They are open to anyone and are attended by DNOs and developers. Details can be found on the [ENA Events website](#).

Improvements made to DNO Services

In recent years, there have been a number of improvements to DNO services as a response to these drivers and feedback, including:

- Increased internal resources;
- Improved provision of information, including more detailed breakdown of costs, web portals, decision support tools/application hotline, and capacity “heat maps”, indicating areas that can more readily facilitate connections;
- Holding stakeholder and customer events; and

- Exploring the possibility for discussions prior to formal application (“connection optioneering”). This process is being carried out in different ways by different DNOs. Refer to your DNO for more information.

DNOs have promised to bring about continued improvements, including:

- Shortening connection timescales;
- Enhancing the publicly available network capacity information, eg. contracted capacity reports;
- Publishing case studies; and
- Enhancing the connection application and the wayleaves/consents processes.

DNOs publish Distributed Generation 'Work Plans' that outline progress against improvement initiatives. Check your DNO's Distributed Generation web pages.

Section 3.3: G99 Type A, An Overview of Getting Connected

In this section:

- Introduction
- The main tasks in the process of connecting Type A Power Generating Modules under EREC G99
- A discussion on connecting to an IDNO network

Introduction

This section describes the process for connecting Type A Power Generating Modules under EREC G99.

Under EREC G99, the technical and compliance requirements are less onerous for Type A Power Generating Modules, compared with Types B to D. A Type A Power Generating Module has a capacity between 0.8 kW and 1 MW, and is connected below 110 kV. However, this G99 section only applies to Type A Power Generating Modules > 16 A per phase. If you are installing a Power Generating Module that is ≤ 16 A per phase, you should refer to the G98 section.

Figure 7 Figure 7 shows the key steps in the connection process. These tasks are based on the requirements set out in EREC G99.

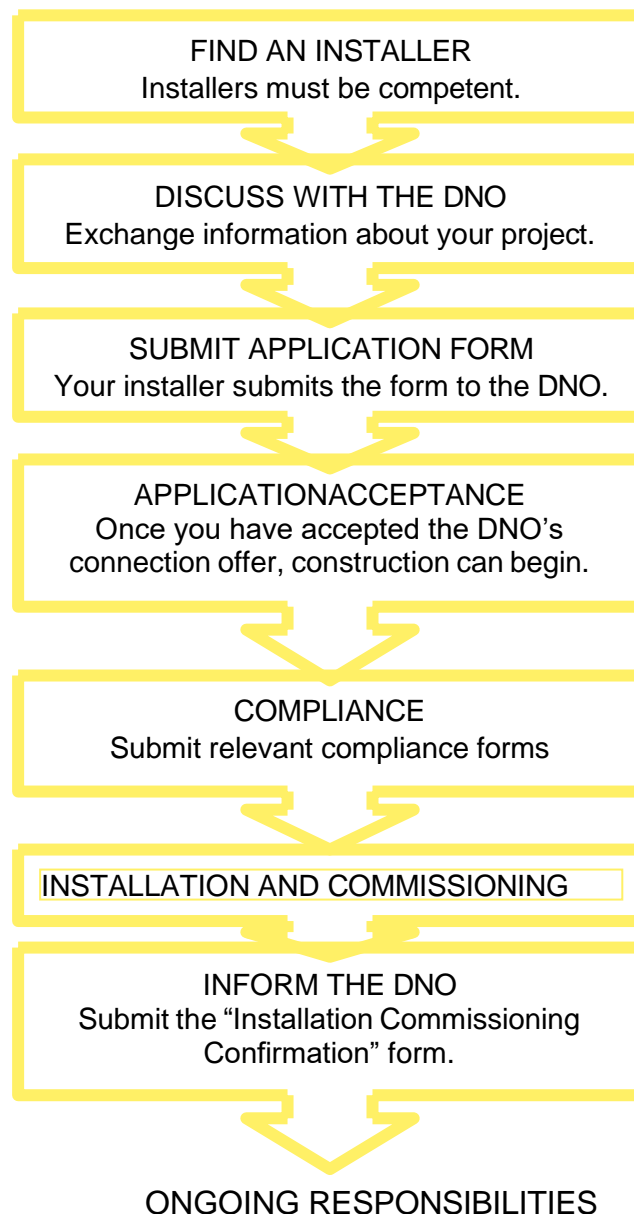

Figure 7: Presenting key steps in connection process required by EREC G99

Note that this document covers the process for connecting generation to the distribution networks in GB. Northern Ireland has different connection arrangements, for example different versions of Engineering Recommendations G98 and G99 are in use. See www.nie.co.uk.

Getting Connected – Main Tasks

Finding an installer

The first task is to find a competent installer. There are companies who design, install and commission domestic generation. They can fully certify and sign off installations. For installations up to 50 kW, certified generation products and installers can be found on the following website: <https://mcscertified.com/>

The Microgeneration Certification Scheme is operated by the MCS Service Company.

Discussions with the DNO

You must discuss your plans with the DNO before starting work. You should do this as soon as possible in your planning, as the DNO's response may have a big impact on how you plan your project. You may discuss the feasibility of your connection, and if there will be any charges for connection (charges are discussed further in [Section 5: Costs and Charges](#)).

All DNOs provide information to support generation developers, such as capacity heat maps, on their websites. These can be an important source of information. In addition, there may be dedicated generation 'surgeries' or 'drop in' sessions to discuss your project with the DNO.

Alternative Connections

Each DNO's current approach to offering alternative connection offers, such as Active Network Management, may be found on their website, noted in any connection offer or determined by discussion with the DNO.

Make contact with the DNO

Extra information can be obtained by making early contact with the DNO to discuss your project. This may be within dedicated generation 'surgeries' or 'drop in' sessions arranged by the DNO. Discussions might include:

- How close your proposed generation site is to the existing network;
- Whether there are any other planned Distributed Generation projects in the same area; and
- Whether there is any "spare" capacity in the network.

Feasibility studies (Optional)

At this stage, you could have feasibility studies carried out to assess possible connection layouts and indicative costs. These studies can be conducted by the DNO or an external contractor, for a fee. If you do opt for feasibility studies, they should take into account the standard of security required in the connection between your generating equipment and the DNO's network.

Decide who will construct the connection

A key decision you have to take is whether to:

- appoint an Independent Connections Provider (ICP) to do the Contestable work and the DNO to do the No contestable work; or
- appoint the DNO to carry out all of the work required to provide the connection.

Using an ICP to install the contestable work allows the work to be competitively bid for, meaning that it could bring some cost advantages. At the same time, using an ICP results in an additional relationship between the DNO and ICP which will need to be managed. If you are considering contracting an ICP to undertake the Contestable work, you may wish to invite quotations from a number of ICPs, as well as the DNO for comparison.

Submitting an application form

Once you have planned the project and exchanged information about your plans with the DNO, it is time to submit an application form. If your Power Generating Module is less than 50 kW three-phase or 17 kW single-phase, then you can use a simplified application form. The format of the simplified application form is given in Annex A.1 of EREC G99, [which is available from the Energy Network Association's website](#). G99 is also

available via the [DCode](#) website. Your installer should submit the application form on your behalf. For larger schemes, you should use the standard application form, which is generally available on DNOs' websites.

You should do your best to provide as much of the information required in the application form as possible, to ensure your quote is as accurate as it can be. If you have difficulty filling out this form, you can discuss this with your DNO or engage an adviser such as an engineering consultant to assist you.

Application acceptance

When you submit your application form you need to include technical details of the equipment. The DNO needs this information to assess the impact that your generating equipment may have on the network.

Once the DNO has conducted these assessments, they will produce a connection offer. This will specify the conditions for your connection and inform you of any connection charge that you may be asked to pay (charges are discussed further in [Section 5: Costs and Charges](#)). You should ensure that you fully understand this offer before accepting it. You should discuss questions with your DNO if you are unsure. Connection offers are time limited. Your DNO will inform you how long the offer is valid for. If a Connection Offer has expired, there is no guarantee that the same offer will be made again, particularly if your development is in an area where there are many Distributed Generation projects.

Once accepted, Connection Offers may be withdrawn if the DNO feels that your plant is not progressing at a reasonable rate. This is to prevent spare capacity being 'reserved' for projects that in practice are not actually being built. A best practice guide to progression milestones was published in November 2016 which your DNO may use to track the progress of your project. You may be asked to provide regular updates about the progress of your project. This will enable the DNOs to proactively manage the queue on behalf of generation customers.

Enter into agreements with the DNO

You need to enter into a number of agreements with the DNO before your generating unit(s) can start operating, such as:

- A Connection Agreement
- An Adoption Agreement (only if you are using an ICP for your project)
- An agreement covering the arrangements for operating the interface between the distribution network and your generating equipment. This may be contained in a Schedule to the Connection Agreement, or in a separate agreement such as a Site Responsibility Schedule or Joint Operational Agreement

Some of these agreements will be in place before construction begins.

Compliance

Power Generating Modules can:

- Be Fully Type Tested, or
- Comprise some Type Tested equipment, and/or use manufacturers' information to demonstrate compliance, and/or also require additional site testing.

Note that there may be a need to demonstrate compliance with power quality standards even if other aspects are type tested.

If your Power Generating Module is:

- Fully Type Tested, and
- registered with the Energy Networks Association Type Test Verification Report Register

then your application should include the Manufacturer's reference number (the Product ID). In all other cases, you need to provide the DNO with a Compliance Verification Report. The format of these reports is given in Annex A.2 of EREC G99.

There are different forms for Synchronous Power Generating Modules and Power Park Modules.

These forms are completed by the manufacturer of your Power Generating Module. However, you (or your installer on your behalf) should obtain these and submit them to the DNO as part of the connection process.

Installation and Commissioning

You should maintain close contact with the DNO throughout construction. This is so that you are aware of the timeline of any reinforcement works that they need to do, and you can plan your project with this in mind. Commissioning can only take place once the construction is complete. EREC G99 details the commissioning tests that you or your installer needs to perform. For generating units covered by EREC G99, it is your obligation to undertake appropriate commissioning tests, which the DNO may choose to witness. For a Fully Type Tested Power Generating Module connected at LV, your DNO will not normally need to witness the commissioning testing. However, your DNO may choose to do so. If this is the case, they will state this in their Connection Offer.

If your commissioning tests are being witnessed by the DNO, you or your installer should discuss the scope of the testing with the DNO from an early stage, and must submit the scope, time and date of the testing at least 15 days before commissioning takes place.

Informing the DNO

You should notify the DNO **at least 28 days before** commissioning the Power Generating Module and provide them with information on the installation and the full results of the commissioning tests. This information is captured in two forms, both of which are available in EREC G99 and on the ENA website:

- The Installation Document can be searched at ([Form A.3](#))
- Site Compliance and Commissioning Test Form ([Form A.2-4](#)), where required, e.g. if the interface protection is not Type Tested and needs to be tested onsite.

If your commissioning is being witnessed by the DNO, then these forms can be filled out and handed to the DNO representative witnessing.

The forms include a declaration that the installer must sign. This states that the installation complies with EREC G99.

Note: DNOs may have their own versions of these forms on their websites—a web search should help you locate the forms you need or try contacting your DNO.

Put commercial arrangements in place

If you have made arrangements with a supplier to buy electricity that you export, it is your responsibility to keep them informed of the proposed commissioning programme. In particular they should know the date you expect imports and exports across the connection to start.

Ongoing responsibilities

Although the focus of this Guide is to inform you about the process of connecting your generation to the distribution network, you should be aware that once it is connected you have some responsibilities. These include:

- Keeping your generation equipment maintained by someone who is competent to do so;
- Performing periodic tests that are required by the DNO. They will discuss these with you;
- Informing the DNO if there are changes to the installation that affect the generating characteristics;
- Complying with Health and Safety requirements;
- Inform the DNO if something happens that affects the compliance of your Power Generating Module with EREC G99; and

- When you are decommissioning your generating unit(s), you need to send the DNO certain information. This is detailed in EREC G99 Annex D.1.

Annex D.3 in EREC G99 is called “Main Statutory and other Obligations” and summarises the main obligations on generators.

EREC G99 was introduced in May 2018. It is based on EREC G59, which was revised to take account of a European Network Code called Requirement for Generators. Generation connecting to the distribution network must connect under EREC G98 or G99.

Management of DNO Connection Queues:

As discussed on page 36 and 37 the ENA has published their action plan to improve and accelerate connection applications which coincides with NGESO’s 5-point plan to manage transmission connections. One of the ENA actions is to reform the distribution connection queue. Refer to the DNO’s and ENA’s website to understand their position on this further.

Changes to your Power Generating Module

If you need to replace a component of your Power Generating Module, or its protection system or interface protection, you must notify the DNO before making changes. You and the DNO will need to reach agreement on the significance of the change. If it is considered a small change, you will only need to confirm the compliance of the affected component with EREC G99.

However, if it is a significant change (eg you increase the capacity of your Power Generating Module), you will need to agree with the DNO the approach to be taken with the replacement equipment and in many cases submit a new Standard Application Form for the new equipment.

If you have an installation that was connected under EREC G59 and you replace a major component you should notify the DNO if the change alters the operating characteristics of the generating unit. If you replace all or part of the interface protection you should notify the DNO as they will need confirmation that the new protection complies with EREC G59 and may want to witness the commissioning of the new protection.

If you replace a generating unit or Power Generating Module that has been installed under EREC G59 you will need to discuss with the DNO whether the new equipment needs to comply with EREC G59 or be upgraded to be fully compliant with EREC G99.

For the addition of new Power Generating Modules, New and Existing Generation.

Getting Connected – IDNO’s Networks

The process for connecting your Distributed Generation to an IDNO’s network follows EREC G98 or G99, and is therefore similar to connecting to a DNO’s network. IDNOs are licensed entities and are bound by some of the same licence conditions as DNOs, including certain performance standards such as timescales for responding to requests for quotes. The majority of what is included in this guide applies to both DNO and IDNO connections. However, there are a few key differences for a Distributed Generation connection to an IDNO network:

- Provision of Information: IDNOs have a reduced set of licence conditions compared with DNOs, and they are not obliged to provide the same documents for customers. IDNOs are not required to produce Long Term Development Statements nor Connection Charging methodologies and statements.
- Interaction between the IDNO and the Host Network: When an IDNO receives an application for connection for Distributed Generation, they design and build the network infrastructure and connect to the host network, which could be a DNO or IDNO. If your generation project would cause certain network parameters to exceed defined limits, such as voltage or export to the host network, the IDNO and host network will explore options for accommodating your project. This discussion will take place

between the IDNO and the host network, and will not involve you directly. However, the IDNO may then discuss different options with you for the most appropriate generation project to be connected.

- **Formal Agreements:** IDNOs will not necessarily insist on the same set of formal agreements that the DNOs will. Agreements such as the connection and adoption agreements may not be required.

To determine whether you are connected to a DNO or IDNO network, refer to Table 5

Section 3.4: G99 Type B-D, An Overview of Getting Connected

In this section:

- Introduction
- The main tasks in the process of getting connected for Type B, C or D Power Generating Modules
- What needs to happen after equipment has been commissioned
- Additional tasks if the Power Generating Facility is classified as being medium or large
- A discussion on connecting to an IDNO network
- Guidance on where to find more information

Tip: Read the information boxes for definitions or explanations of terms that may be new or unfamiliar.

Introduction

The tasks that you have to undertake to get connected vary with the size of the generating capacity. In general, the bigger the Power Generating Module, the more complex the connection requirements.

This section focuses on the information exchanges that take place between you, as the developer, and the DNO. It also presents the key actions that you have to complete to connect your Power Generating Module. These tasks are based on the requirements set out in Engineering Recommendation (EREC) G99, which is described on in the introductory chapter.

The key stages of the connection process are illustrated in the flow chart in Figure 8. They are discussed in more detail in this section. Power Generating Modules are classified as Type A to D – refer to the note on RfG Types A to D on page 20– and the Type classification defines the connection process and compliance requirements. Power stations can also be classified as Medium or Large, in the Distribution and Grid Codes respectively. Connecting larger Power Generating Modules to the distribution network involves more complexities than with smaller units. This is due to the increased likelihood that the Power Generating Module will impact on the distribution and transmission systems, and involvement with the electricity market. There is a section that explains these complexities in more detail.

This Guide describes the process for connecting under EREC G99.

Note that this document covers the process for connecting generation to the distribution networks in GB. Northern Ireland has different connection arrangements, for example different versions of Engineering Recommendations G98 and G99 are in use. For more information, refer to the Northern Ireland Electricity website: <https://www.nienetworks.co.uk/home>

Connection Process Overview

Section 3.4: G99 Type B-D, An Overview of Getting Connected

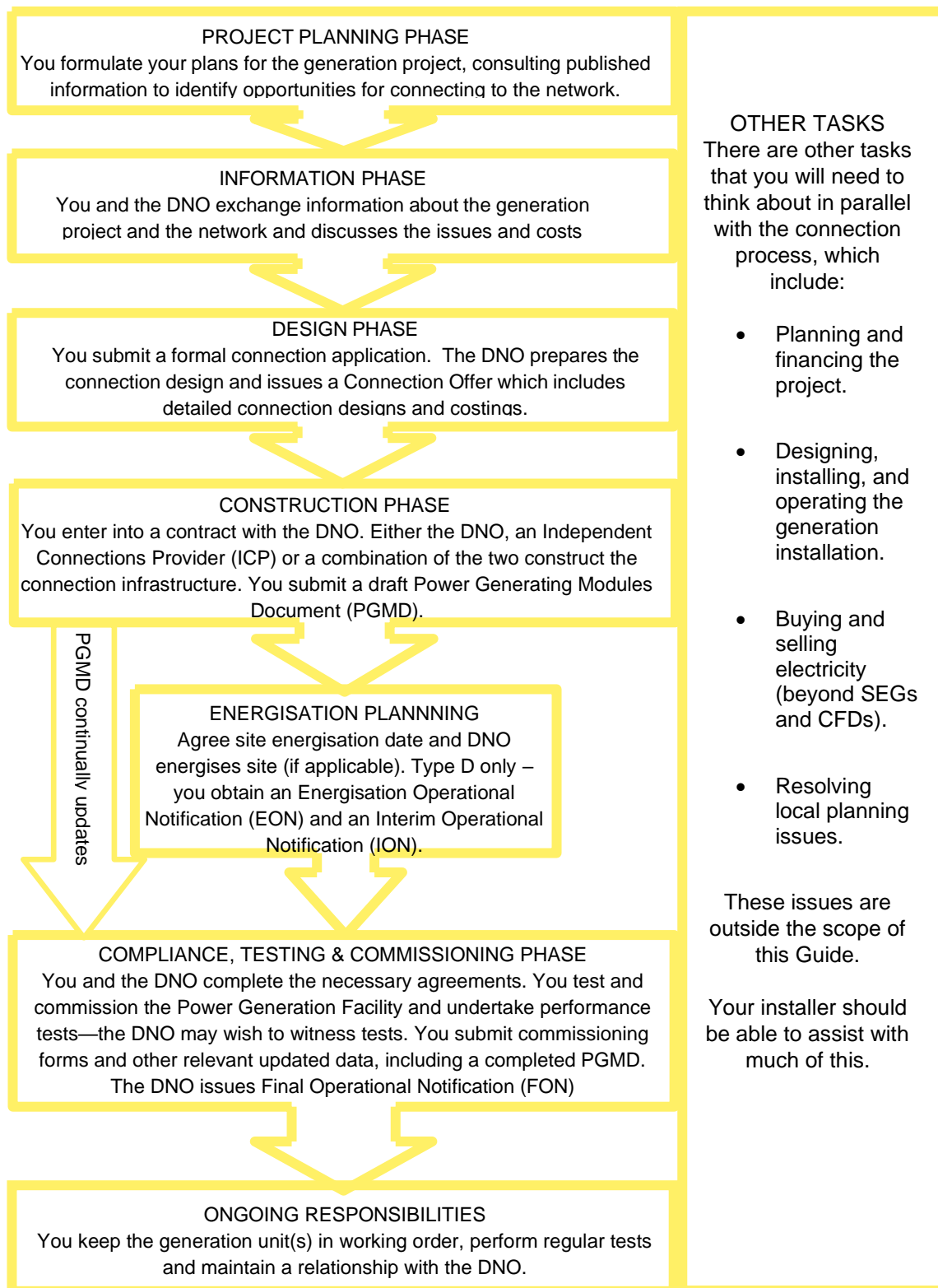

Figure 8: Flowchart showing connection process.

Getting Connected – Project Planning Phase

The key tasks in the project planning phase are to:

- Identify your DNO (or IDNO)
- Look at publicly available information
- Make early contact with your DNO
- Decide whether to ask for feasibility studies

Identify your DNO (refer to Table 5)

There are publicly available documents about the distribution and transmission networks which will enable you to assess the potential to connect generation in the geographical area you're interested in. These include:

- The DNO's Long Term Development Statement (LTDS, see information box below).
- National Grid Electricity Transmission's Electricity Ten Year Statement.

Along with EREC G99, the Distribution Code also sets out some of the technical requirements for connecting to the DNO's network—it may be useful to consult it at this early stage. All DNOs provide additional information to support generation developers, such as capacity heat maps, on their websites. These can be an important source of information.

Alternative Connections

Each DNO's current approach to offering alternative connection offers, such as Active Network Management, may be found on their website, noted in any connection offer or determined by discussion with the DNO.

Make contact with the DNO

Extra information can be obtained by making early contact with the DNO to discuss your project. This may be within dedicated generation 'surgeries' or 'drop in' sessions arranged by the DNO. Discussions might include:

- Whether there are any other planned Distributed Generation projects in the same area; and
- Whether there is any "spare" capacity in the network.

Feasibility studies (Optional)

At this stage, you could have feasibility studies carried out to assess possible connection layouts and indicative costs. These studies can be conducted by the DNO or an external contractor, for a fee.

Note: Many DNOs will provide an initial budget estimate free of charge.

Long Term Development Statement (LTDS)

DNOs prepare a Long Term Development Statement (LTDS) every year. The information should assist anyone considering opportunities (eg. developing Distributed Generation) and help potential users to identify constraints in the network. It covers areas such as:

- Development plans for the network
- Identifying parts of the network that are likely to reach certain limits within five years
- Any plans the DNO has to relieve these stressed areas

An introductory chapter is generally available on the DNO's website. It will allow you to understand the scope of information provided, and assess whether it will be useful to you. DNOs will give access to the full document on request. Links to the LTDSs are at the end of this section. The LTDS includes detailed information on parts of the distribution network operating at 33kV and above, with generic information being provided on the 11kV network.

Getting Connected - Information Phase

The key tasks in the information phase are to:

- Discuss your plans with the DNO at an early stage
- Maintain close communication with the DNO throughout the project
- Decide whether you will use an Independent Connections Provider (ICP) to do the Contestable work

Initial meeting and communication with DNO

Seek initial meetings with the DNO at an early stage in the development programme to:

- outline the proposed generation project to the DNO;
- discuss the process that the DNO will wish to follow through the various stages of the connection development; and
- ask the DNO to clarify which work will be Contestable and which will be Non-contestable
- (see information box below).

You may wish to ask the DNO to prepare an indicative connection design and a budget estimate (after the DNO has undertaken any necessary studies), noting that some DNOs might charge for these.

It is important to maintain close communications with the DNO. This will make sure that the connection design develops in a way that fully reflects the operating characteristics of the equipment.

Decide who will construct the connection

A key decision you have to take is whether to

- appoint an Independent Connections Provider (ICP) to do the Contestable work and the DNO to do the Non-contestable work (often called a SCL15 application, see information box on page 33); or
- appoint the DNO to carry out all of the work required to provide the connection. (often referred to as a Section 16 application, see information box on page 33).

This will affect the way the connection process proceeds, which is outlined in the next section: Getting Connected – Design Phase

Using an ICP to install the contestable work allows the work to be competitively bid for, meaning that it could bring some cost advantages. At the same time, using an ICP results in an additional relationship between the DNO and ICP which will need to be managed. If you are considering contracting an ICP to undertake the Contestable work, you may wish to invite quotations from a number of ICPs, as well as the DNO for comparison.

Contestable and non-contestable work

There are certain tasks that DNOs do themselves, so that they can maintain co-ordination and control of their networks. These tasks are called Non-contestable work, as they are not open to competition. Conversely, when work is open to competition it is called Contestable work. Contestable work can be conducted by Independent Connections Providers (ICPs). Often, tasks that involve reinforcing existing equipment are non-contestable. Tasks which include the installation of new infrastructure or extensions to the network tend to be contestable.

For more on this, see the [Section 7: Technical and Commercial Interfaces: Competition in Connections](#).

Getting Connected – Design Phase

The key tasks in the design phase are to:

- **Submit a formal connection application** to the DNO with supporting technical information
- Receive, review, discuss and agree on the Connection Offer from the DNO
- Enter into a **formal agreement** with the DNO and/or the ICP, as required

The choice of who will be providing the contestable work for your connection (DNO or ICP) will affect the process you will follow. This is explained in this section and illustrated in the flow diagram on page 34.

Submit a formal Connection Application

The standard application form includes the technical details of the equipment that the DNO needs to design the connection.

You should do your best to provide as much of this information as possible, to ensure your quote is as accurate as it can be. If you have difficulty filling out this form, you can discuss this with your DNO or engage an adviser such as an engineering consultant to assist you.

A standard application form is used by all DNOs and the DNO will tell you what supporting information they need. An online application process may be available on your DNO's website.

The process of submitting a connection application is covered in [Section 4: The Connection Application](#). If the DNO is doing all the work (Contestable as well as Non contestable), then the connection application will be submitted by you (or your developer / installer).

If you contract an ICP they will generally liaise with the DNO and arrange for the DNO to provide them with a quote for the Non contestable work. This will enable the ICP to provide you with the total cost for the Contestable and Non-contestable work.

Even if you contract an ICP, you will generally need to have a relationship with the DNO as well, and some formal agreements may still be held directly between you and the DNO.

The Connection Offer

You, or an ICP acting on your behalf, will receive a connection offer from the DNO. This contains the technical and commercial terms under which the DNO is prepared to carry out the Non-contestable work and, if applicable, the Contestable work.

The DNO must provide the Connection Offer within certain timescales. These timescales are given in the information boxes for SLC15 (when the DNO is providing only Non contestable work) and Section 16 (when the DNO is providing both Contestable and Non contestable work) applications.

The Connection Offer must be reviewed carefully—you may wish to hire an independent consultant to help you. DNOs will be willing to discuss and agree the details of the offer before you reach a formal agreement.

If you are unhappy with the connection offer, DNOs have a complaints process on their websites. In the event that you are still unable to reach an agreement with the DNO, the matter can be referred to the Energy Ombudsman, and ultimately to Ofgem. See page 39 for a note on dealing with disputes.

When considering the design options, there may be options that trade off the need for reinforcement (and hence reduce the capital costs) against increased operational restrictions. This is discussed more in [Section 7: Technical and Commercial Interfaces: Operational Issues](#).

Connection Offers are time limited. Your DNO will inform you how long the offer is valid for. If a Connection Offer has expired, there is no guarantee that the same offer will be made again, particularly if your development is in an area where there are many Distributed Generation projects.

Once accepted, Connection Offers may be withdrawn if the DNO feels that your plant is not progressing at a reasonable rate. This is to prevent spare capacity being 'reserved' for projects that in practice are not actually being built. The User Guide into the Queue Management was published in July 2021 on the [ENA website](#) under "Customer information provision and connections", which is called "ON21-WS2-P2 Updated Queue Management User Guide (30 Jul 21)". You may be asked to provide regular updates about the progress of your project. This will enable the DNOs to proactively manage the queue on behalf of generation customers.

There is more information about this in [Section 4: Connection Application: Connection Application Process](#).

Formal Agreement

Once you have accepted the Connection Offer, you have entered into a formal agreement with the DNO. The connection process that you will typically follow is illustrated in Figure 9.

Standard Licence Condition 15 (SLC15)

In order to maintain their licence to own, operate and maintain a distribution network, DNOs are required to comply with a set of licence conditions, called Standard Licence Conditions (SLC). SLC15 is called “Standards for the provision of Non-Contestable Connection Services”. It applies when you are requesting only Non-contestable services from the DNO. SLC15 sets standards in terms of timescales for the DNO to perform certain tasks such as provide quotes, respond to design submissions, and complete final works.

Under SLC15, the timescales for the DNO to provide a quotation for work are:

- 30 working days for Low Voltage (LV) generation connections;
- 50 working days for High Voltage (HV) generation connections; and
- 3 months for Extra High Voltage (EHV) generation connections.

For definitions of LV, HV and EHV please see [Section 5: Costs and Charges: Ongoing Charges](#).

Section 16 of the Electricity Act

The Electricity Act (1989) is one of the primary pieces of legislation governing the power sector in the UK. Section 16 of the Act is called “Duty to supply on request” and sets out the DNO’s obligation to provide connections for electricity supply. This is the legislation that governs applications for generation connections where the DNO is requested to undertake both the Contestable and the Non-contestable work.

The timescales for the DNO to provide a quotation for both Contestable and Non-Contestable work are:

- 45 working days for LV generation connections; and
- 65 working days for HV and EHV generation connections.

For definitions of LV, HV and EHV please see [Section 5: Costs and Charges: Ongoing Charges](#).



Figure 9: The connection process.

Getting Connected – Construction Phase

The key tasks in the construction phase are to:

- **Enter into agreements** with the DNO before the equipment starts operating
- **Submit** a draft Power Generating Module Document (PGMD)
- **Communicate with the DNO** about reinforcements they may be making to the distribution network
- For Type D Power Generating Modules only, **obtain** an Energisation Operational Notification (EON) and an Interim Operational Notification (ION)
- **Focus** on other activities

Enter into agreements with the DNO

You need to enter into a number of agreements with the DNO before your generating unit(s) can start operating, such as:

- A Connection Agreement
- An Adoption Agreement (only if you are using an ICP for your project)
- An agreement covering the arrangements for operating the interface between the distribution network and your generating equipment. This may be contained in a Schedule to the Connection Agreement, or in a separate agreement such as a Site Responsibility Schedule or Joint Operational Agreement

Some of these agreements will be in place before construction begins.

Submit a draft PGMD

A Power Generating Module Document (PGMD) is a document that you submit to the DNO to confirm that your Power Generating Module(s) comply with EREC G99. It includes a checklist of criteria to meet, and a pointer to other documents that demonstrate compliance (eg reports of simulation studies, results of type testing, manufacturers' information, site tests). You should submit a draft version of the PGMD to the DNO at least 28 days before you want to synchronise your Power Generating Module for the first time.

You re-submit the PGMD once your Power Generating Module has been commissioned, to update it with final data. An example of the PGMD is given in EREC G99 in:

- Annex B.2 for Type B Power Generating Modules
- Annex C.2 for Type C and Type D Power Generating Modules

You must submit one PGMD for each Power Generating Module.

Management of DNO Connection Queues:

As discussed on page 36 and 37 the ENA has published their action plan to improve and accelerate connection applications which coincides with NGENSO's 5-point plan to manage transmission connections. One of the ENA actions is to reform the distribution connection queue. Refer to the DNO's and ENA's website to understand their position on this further.

The PGMD has a common cover sheet for the whole Power Generating Facility, and then different sections, depending on whether the Power Generating Module is Synchronous Power Generating Module or a Power Park Module.

Communicate with the DNO

Clear communication lines should be established between you, the DNO and the ICP (where applicable). This is in order to manage the interface between their work, make sure that you both agree on a coordinated programme for completion of the work, and make sure that the work meets the required standards.

Obtain an EON and an ION

If you are installing a Type D Power Generating Module there are additional notifications, you need to obtain. Before energising your internal network for the first time, you need an Energisation Operational Notification (EON). You obtain this from your DNO by:

- providing a revised standard application form with the most up to date information, and
- notifying the DNO that you are ready to energise your installation at least 28 days before you wish to do so.

When you want to synchronise, your Power Generating Module for the first time you need to obtain an Interim Operational Notification (ION). You obtain an ION by submitting a draft PGMD (see above). The ION may impose limitations on the maximum allowed output of your plant.

Focus on other activities

During this phase you need to focus on a number of other tasks. These tasks include the following:

- Complete the construction of the generating unit(s), which should meet IET Wiring Regulations — make sure you are using an approved contractor.
- Make appropriate provisions for wayleaves in any lease option required—see Section 4: The Connection Application.
- Appoint a Meter Operator—more on this in the Section 5: Costs and Charges.
- Finalise negotiations with a Supplier who will purchase your energy.

EREC G99 was introduced in May 2018. It is based on EREC G59, which was revised to take account of a European Network Code Requirement for Generators. Generation connecting to the distribution network must connect under EREC G98 or G99.

Connection Agreements

The Connection Agreement covers the conditions under which your generating equipment is allowed to be physically connected to the DNO network and remain connected and energised while the network is operating normally. For example, they set out technical and safety requirements. These agreements are likely to be standard documents with project-specific annexes. They will probably be prepared by the DNO for you to discuss, agree and sign.

Firm and Non-firm connections

When submitting a request to import or export onto the distribution network, the DNOs will offer 2 types of connections:

- Firm connection
- Non-firm connection

A firm connection is a guaranteed allocated capacity to import or export at any given time in a year as agreed in the connection agreement between the connecting customer and the DNO.

A non-firm connection is a flexible connection offer, which allows connecting customers to connect onto the network on the condition that the DNO can curtail their capacity when the network is constrained.

For connection applications after 1 April 2023 the DNO may offer a curtailable (non-firm) connection to allow a quicker connection to the network. This will include an agreement that your connection may be restricted at certain times. The amount of curtailment will be measured and compared against an agreed limit above which the DNO will pay you compensation. The curtailment will cease after an agreed end date by which time the

necessary network reinforcement should have been made. See section 5.5 Connection Charges for more information.

Getting Connected – Testing and Commissioning

In summary, the key tasks in the testing and commissioning phase are to:

- Provide the DNO with detailed information about the test scope at least 28 days before the proposed commissioning date
- Make sure you have careful liaison with the DNO leading up to and during commissioning
- Undertake commissioning tests and submit commissioning forms to the DNO
- Put commercial arrangements in place and keep the Supplier informed on the commissioning progress

For generating units covered by EREC G99, it is your obligation to undertake appropriate commissioning tests, which the DNO may choose to witness.

Provide the DNO with detailed information

According to EREC G99 you need to provide the DNO with detailed information about testing and commissioning at least 28 days before the proposed commissioning date. This will give the DNO time to make decisions about witnessing commissioning and inspecting the installation. Commissioning test requirements are discussed in EREC G99, section 15.3 (for all units) and 15.4 (for non type-tested units). The DNO will assess the proposed schedule of tests and confirm the commissioning date. More detailed information on commissioning is provided in Sections 16 to 19 of EREC G99, depending on the Type classification of your Power Generating Module.

Careful liaison with the DNO

Careful liaison with the DNO will be required during the process of commissioning the connection. This will relate to the programme for commissioning the rest of the generating equipment. In particular the DNO will want assurance on the state of readiness of your unit(s) on your side of the connection. You may have auxiliary equipment that is fed through the connection. If this is the case, you will require the connection to be ready before the Power Generating Module is ready to be operated. This will require close coordination with the DNO. This is formalised as the requirement for an EON (Energisation Operational Notification) for Type D Power Generating Modules.

Undertake commissioning tests

You need to record the results of the tests in the Installation and Commissioning Confirmation Form ([Form B3](#) for Type B Power Generating Modules and [Form C3](#) for Types C and D Power Generating Modules). If you are not using Type Tested interface protection and / or you are demonstrating compliance with any other requirements on site you also need to record the results of the tests in the Site Compliance and Commissioning test requirements ([Form B2-2](#) for Type B Power Generating Modules and [Form C2-2](#) for Types C and D Power Generating Modules).

You also need to submit final data required in the PGMD and standard application form (eg if estimated data was previously used or if information was not previously provided). When the DNO is satisfied that you have demonstrated compliance with EREC G99 they will issue you with a Final Operational Notification (FON). This will form part of your Connection Agreement.

Put commercial arrangements in place

If you have made arrangements with a supplier to buy electricity that you export, it is your responsibility to keep them informed of the proposed commissioning programme. In particular they should know the date you expect imports and exports across the connection to start. The supplier can advise you on making contact with the relevant electricity market authorities (e.g. Elexon). Apart from Feed-in Tariffs and Contracts for Difference,

trading electricity is beyond the scope of this Guide. However, we have referenced some useful documents on this topic at the end of this section. Commercial arrangements need to be in place for the purchasing and sale of energy during the commissioning process. These arrangements include making sure the correct metering is installed and working before you start importing and exporting energy.

Getting Connected – Ongoing Responsibilities

EREC G99 sets out a number of ongoing requirements for you as a developer of Distributed Generation. These are beyond the scope of this guide, but include:

- Test the interface protection and generating equipment. The frequency of these tests should be agreed in discussions with the DNO.
- Keep the Power Generating Module maintained by someone who is competent to do so.
- Inform the DNO if there are changes to the installation that affect the generating characteristics (see below).
- You also need to comply with Health and Safety requirements.
- Inform the DNO if something happens that affects the compliance of your Power Generating Module with EREC G99.
- When you are decommissioning your generating unit(s), you need to send the DNO certain information. This is detailed in EREC G99 Annex D.1.

Annex D.3 in EREC G99 is called “Main Statutory and other Obligations” and summarises the main obligations on generators.

Adoption Agreements

If an Independent Connections Provider (ICP) has constructed some of the connection infrastructure, an Adoption Agreement is required to define the terms under which the DNO will take these connection assets into their control and ownership. This is normally sent out with the formal Connection Offer in the design phase. The Adoption Agreement is held between the DNO and either you or your ICP, depending on your circumstances and the DNO's processes.

Changes to your Power Generating Module

If you need to replace a component of your Power Generating Module, or its protection system or interface protection, you must notify the DNO before making changes. You and the DNO will need to reach agreement on the significance of the change. If it is considered a small change, you will only need to confirm the compliance of the affected component with EREC G99.

However, if it is a significant change (eg you increase the capacity of your Power Generating Module), you will need to agree with the DNO the approach to be taken with the replacement equipment and in many cases submit a new standard application Form for the new equipment.

If you have an installation that was connected under EREC G59 and you replace a major component you should notify the DNO if the change alters the operating characteristics of the generating unit. If you replace all or part of the interface protection you should notify the DNO as they will need confirmation that the new protection complies with EREC G59 and may want to witness the commissioning of the new protection.

If you replace a generating unit or Power Generating Module that has been installed under EREC G59 you will need to discuss with the DNO whether the new equipment needs to comply with EREC G59 or be upgraded to be fully compliant with EREC G99.

For the addition of new Power Generating Modules, see page 27.

Getting Connected – Medium and Large Stations

The Distribution Code defines Medium Power Stations (which is only relevant in England and Wales) and the Grid Code defines Large Power Stations. The definitions of these categories are given in Table 8 Table 8 below. Classification as medium or large is based on the aggregate registered capacity of all Power Generating Modules in the Power Generating Facility (as distinct from RfG Type A to D classification).

Table 8: Table showing registered capacity categories.

	Registered Capacity	
	Medium Power Station	Large Power Station
National Grid Electricity Transmission (England and Wales)	50 to 100 MW	100 MW and above
SP Transmission plc (Southern Scotland)	N/A	30 MW and above
Scottish Hydro Electric Transmission plc (Northern Scotland)	N/A	10 MW and above

Registered Capacity Definition

Registered Capacity is the Active Power (kW) of the Power Generating Module (or Facility). A technical capability of 0.95 power factor is generally required at the Connection Point.

The specific definition of Registered Capacity can be found in ER G98 and ER G99.

There could be an active and reactive power loss between the Power Generating Module and the Connection Point. The active power loss is small and usually ignored in practice.

The Standard Application Form asks for maximum active and reactive export power as well as the Registered Capacity and notes that the Registered Capacity can apply to:

- A Power Generating Facility. This is the total maximum Active Power capacity of the Power Generating Module(s) in the Power Generating Facility, minus the power consumed by the generation process. For a Power Generating Facility with no other demand site, you should take account of the requirement to produce Reactive Power at the Connection Point which will mean considering other equipment such as transformers and cables connecting the Generating Units to the Connection Point. For a Power Generating Facility embedded in a private network with demand it is recommended that you discuss the requirement to produce Reactive Power with the DNO. Hence the Registered Capacity (kW) will generally be less than the Apparent Power (kVA).
- A Power Generating Module. This is the maximum Active Power capacity of the Generating Unit(s) comprising the Power Generating Module, minus the power consumed by the generation process. It needs to take account of the requirement to produce Reactive Power, and whether this is at the Connection Point or at the Module terminals. Hence the Registered Capacity (kW) will generally be less than the Apparent Power (kVA). Where a Power Generating Module comprises inverters, the maximum Active Power capacity of the Generating Unit(s) is the lesser of the Inverter(s) rating or the rating of the energy source.

Examples are included in Appendix A to show the process for inverter sizing and determining registered capacity.

To connect medium or large power stations the connection process is the same as the one described so far. However, there are more complexities with power stations of this size due to involvement with the electricity market and the increased likelihood that the units will impact on the distribution and transmission systems. This means you are likely to be involved with a number of other processes, which include:

- **Generation licence** (all generation with capacity over 100MW. Generation between 50 and 100MW may be exempt): For more information on Generation Licences, please see [Section 4: The Connection Application](#).
- **Balancing and Settlement Code (BSC) participation**: If you have a generation licence you are required to become a party to the BSC. Otherwise, whether you participate in the BSC depends on how you want to trade electricity. You need to consider this carefully.
- **Connection and Use of System Code (CUSC)**: If you have a generation licence you will need to become a party to the CUSC. Non-licensed generators can choose to sign the CUSC to benefit from certain trading arrangements. You can see which sections, if any, of the CUSC apply to you in Section 1 of the CUSC, "[Applicability of Sections and related Agreements Structure](#)".
- **Compliance with the Grid Code**: Medium power stations have to comply with sections of the Grid Code. The Distribution Code describes which sections apply. Large power stations are bound by all of the Grid Code.
- **Agreements with National Grid Electricity System Operator (NGESO)**: For large and medium power stations there are various agreements you have to or may enter into with NGESO. Developers of small generating units may choose to enter into these agreements to benefit from trading opportunities. These agreements are discussed in more detail in the [Section 4: The Connection Application: Generation Licensing](#).

For more information on all of these issues, please see [Section 4. The Connection Application](#) and websites of the following organisations:

- [Elexon](#)
- National Grid ESO

Getting Connected – IDNO's Networks

The process for connecting your Distributed Generation to an IDNO's network follows EREC G99 and is therefore similar to connecting to a DNO's network. IDNOs are licensed entities and are bound by some of the same licence conditions as DNOs, including certain performance standards such as timescales for responding to requests for quotes. The majority of what is included in this guide applies to both DNO and IDNO connections, including allowing the use of Independent Connections Providers (ICP) to construct network extension.

However, there are a few key differences for a Distributed Generation connection to an IDNO network:

- **Provision of Information**: IDNOs have a reduced set of licence conditions compared with DNOs, and they are not obliged to provide the same documents for customers. IDNOs are not required to produce Long Term Development Statements nor Connection Charging methodologies and statements.
- **Interaction between the IDNO and the Host Network**: When an IDNO receives an application for connection for Distributed Generation, they design and build the network infrastructure and connect to the host network, which could be a DNO or IDNO. If your generation project would cause certain network parameters to exceed defined limits, such as voltage or export to the host network, the IDNO and host network will explore options for accommodating your project. This discussion will take place between the IDNO and the host network and will not involve you directly. However, the IDNO may then discuss different options with you for the most appropriate generation project to be connected.
- **Formal Agreements**: IDNOs will not necessarily insist on the same set of formal agreements that the DNOs will. Agreements such as the connection and adoption agreements may not be required.

To determine whether you are connected to a DNO or IDNO network, refer to the guidance on page 16.

The Distribution Code

DNOs are obliged to maintain a Distribution Code under the terms of their licence conditions. The Distribution Code contains technical considerations relating to the connection to and use of distribution systems. Key areas that are covered by the Code include, general conditions, planning and connection, operation, and data registration. There are also guidance notes for information. The requirements in the Distribution Code are explained in more detail in EREC G99 and will be enacted by the Connection Agreement. For more information on the Distribution Code, refer to the Distribution Code website: <https://dcode.org.uk/>. The Distribution Code is under open governance so proposals to make a change to it can be initiated by interested parties. This is done through the Distribution Code Review Panel which includes representatives of various constituencies of generator. A list of current representatives can be found at [distribution code review panel](#).

Where to Find More Information

You are required to comply with a number of technical codes and standards within the electricity industry. You should make sure that you are familiar with the contents of the following key documents, **to the extent that they apply to your specific generating project**:

- the [Grid Code](#) of GB — available free of charge on National Grid’s website
- the [Distribution Code](#) of GB—available free of charge on the Distribution Code website
- [Engineering Recommendation G99](#), Requirements for the connection of generation equipment in parallel with public distribution networks on or after 27 April 2019—available to download free of charge via the [DCode](#) as well as ENA website.
- Engineering Recommendation G59, relating to the connection of generating units to the distribution systems of licensed Distribution Network Operators. This is not applicable to generation connecting after the 27th April 2019. Other useful documents and links
- Independent Connections Providers (ICPs): see the [Lloyds Register](#) website information on the National Electricity Registration Scheme (NERS)
- [National Grid Electricity Transmission Ten Year Statement](#)
- [Metering Codes of Practice](#)
- Elexon publish [Simple Guides to the BSC](#) which may be of interest, and Electricity Trading Arrangements: A Beginner’s Guide for more information on trading electricity.
- The [Connection and Use of System Code \(CUSC\)](#) is available free of charge on National Grid’s website
- National Grid also has information on their website about [Connections and Agreements](#)
- The [Balancing and Settlement Code \(BSC\)](#) is available free of charge on Elexon’s website
- The [IET Wiring Regulations](#) (British Standard 7671) are available to buy on the IET website
- Ofgem’s information about [how to get an electricity connection](#) for a new building or site
- Long Term Development Statements (LTDS) - see table below for links:

DNO	Link to LTDS
Electricity North West	Long Term Development Statement
Northern Powergrid	Northern Powergrid LTDS
Scottish Power Energy Networks	Long Term Development Statement - SP Energy Networks
Scottish & Southern Electricity Networks	Long term development statements (LTDS) - SSEN
UK Power Networks	Long Term Development Statement and Network Development Plan

National Grid Electricity Distribution	Long Term Development Plans
---	---

Section 3.5: G99 Type A & Type B-D, An Overview of Getting Connected

In this section:

- An explanation of the terms Power Park Modules and Synchronous Power Generating Modules
- Guidance on adding new generation to an existing installation
- Recent developments in the provision of information and customer service standards

Types of Power Generating Module

Power Park Modules and Synchronous Power Generating Modules

Power Generating Modules are classified in EREC G99 as Power Park Modules (PPM) or Synchronous Power Generating Modules (SPGM). Both comprise one or more generating units, which is any apparatus that produces electricity.

Power Park Modules (PPM) are connected to the network either through power electronics (e.g. solar PV or electricity storage devices connected through an inverter) or asynchronously (e.g. some wind turbines are induction or asynchronous generation). They have a single Connection Point to the distribution network.

Synchronous Power Generating Modules (SPGM) are defined in EREC G99 as “an indivisible set of Generating Units (i.e. one or more units which cannot operate independently of each other) which can generate electrical energy such that the frequency of the generated voltage, the generator speed and the frequency of network voltage are in a constant ratio and thus in synchronism.” Where the generating units cannot run independently from each other – e.g. if they have a common shaft – they form a Synchronous Power Generating Module.

In terms of classifying your Power Generating Module as Type A to D – for a Power Park Module, this is based on **the total capacity of all generating units** in the Power Generating Facility (all behind a single Connection Point). For Synchronous Power Generating Modules, this is based on the capacity of **each** Synchronous Power Generating Module, even if there are multiple modules in a Power Generating Facility. This is illustrated in the diagrams.

Power Park Module - the classification of Type A to D is based on the capacity of the Power Generating Module (PGM), which is the total capacity of all generating units (GU) in the Power Park Module (PPM):

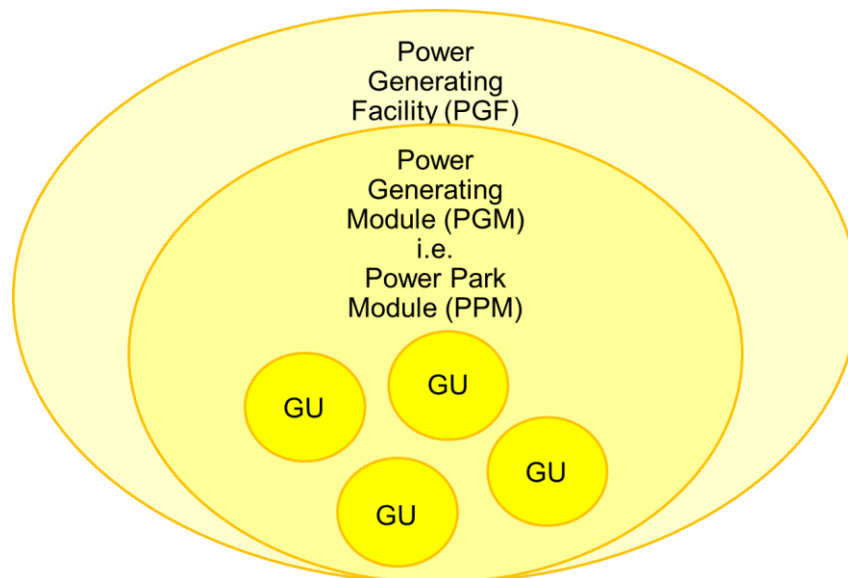

Synchronous Power Generating Module – the classification of Type A to D is based on the capacity of **each** Power Generating Module (PGM) in the Power Generating Facility (PGF):

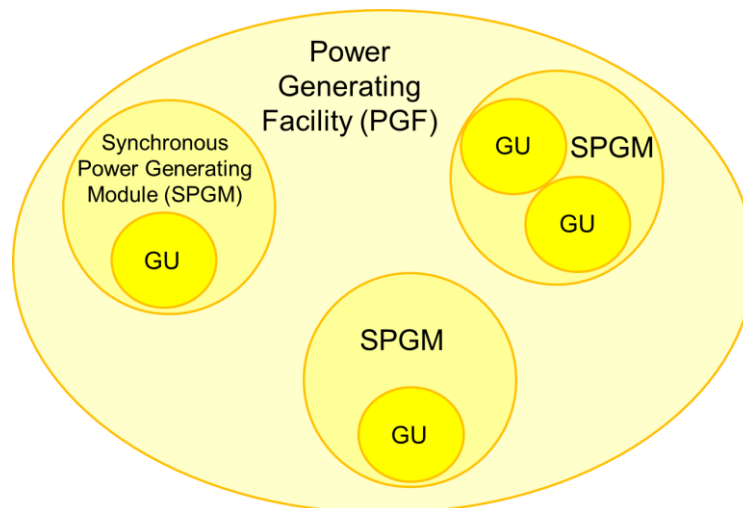

Where generating units are connected via inverters, the inverter rating is deemed to be the generating unit rating.

For example: A Power Generating Facility comprises three 400 kW Synchronous Power Generating Modules (SPGM). Although the capacity of the Power Generating Facility is 1.2 MW, the threshold for requirements is based on the capacity of each Synchronous Power Generating Module. As each is 400 kW, each SPGM must meet the Type A requirements in EREC G99.

Another Power Generating Facility comprises three 400 kW generating units (e.g. Wind turbines), which form a Power Park Module (PPM). The capacity of the Power Park Module is the total capacity of all of the generating

units, i.e. 1.2 MW. The Power Park Module must meet the Type B requirements in EREC G99. There are further illustrations of examples in Section 4 of EREC G99.

New and Existing Generation

Power Park Modules

If you are adding new (i.e., connected under EREC G99) generating units to an existing (i.e. connected under EREC G59) Power Park Module installation, the new generating units will be treated as a separate Power Park Module. Only the capacity of the new generating units should be taken into account when determining the Type A to D category of the new Power Park Module (even though all units are behind a single Connection Point).

However, this is not the case if you are adding new generating units to an existing Power Park Module installation, where the existing Power Park Module was also installed under EREC G99. In this case, the total capacity of all generating units in the Power Park Module will determine the Type category.

This is the same irrespective of the technology – e.g. if there are wind turbines and solar panels behind the same Connection Point, it is the total capacity of all units that determines the compliance requirements.

Synchronous Power Generating Modules

If you are adding new (i.e. connected under EREC G99) Synchronous Power Generating Modules (SPGM) to an existing (i.e. connected under EREC G59) installation, the compliance requirements for the new SPGMs are determined by the capacity of each new SPGM.

All Power Generating Modules

In all cases, if because of adding generation to an existing installation the total capacity of all Power Generating Modules (existing and new) exceeds the threshold for Embedded Medium or Large as defined in the Grid Code, then the Power Generating Facility will need to comply with relevant parts of the Grid Code.

There are further examples in EREC G99.

The Connection Point and Interface Protection

If you are installing new Power Generating Modules at an existing site (where the existing Power Generating Modules were connected under EREC G59), and where the interface protection is located at the connection point, you will need to consider the design of the connection including the location of the interface protection to ensure that all the generation on the site meets with all applicable requirements.

Customer Service and Provision of Information

There are a number of drivers for DNOs to provide a good level of service to customers.

Price Control Proposals (RIIO-ED2)

Ofgem administers a price control regime which allows DNOs to earn a fair rate of return while limiting costs passed on to customers. The current price control period is called RIIO-ED2, which runs until 2028. The RIIO-ED2 rules include a number of mechanisms to incentivise DNOs to provide a good service to Distributed Generation customers. The latest information is provided on [Ofgem's website](#).

DNOs publish annual [ICE plans for stakeholder engagement](#).

Guaranteed Standards of Performance

The guaranteed standards of Performance are set out in Standard Licence Condition 15A. They include, for example, maximum timescales in which DNOs must provide you with a quotation (Connection Offer). Ofgem has guidance documents about these Standards on their [website](#).

DER Forum

The DER Forums, hosted by the ENA on behalf of DNOs, are events that are used to explore issues and concerns around Distributed Generation connections, including barriers to Distributed Generation and process issues. They are open to anyone and are attended by DNOs and developers. Details can be found on the [ENA Events website](#).

Improvements made to DNO Services

In recent years, there have been a number of improvements to DNO services as a response to these drivers and feedback, including:

- Increased internal resources;
- Improved provision of information, including more detailed breakdown of costs, web portals, decision support tools/application hotline, and capacity “heat maps”, indicating areas that can more readily facilitate connections;
- Holding stakeholder and customer events; and
- Exploring the possibility for discussions prior to formal application (“connection optioneering”). This process is being carried out in different ways by different DNOs. Refer to your DNO for more information.

DNOs have promised to bring about continued improvements, including:

- Shortening connection timescales;
- Enhancing the publicly available network capacity information, e.g. Contracted capacity reports;
- Publishing case studies; and
- Enhancing the connection application and the wayleaves/consents processes.

DNOs publish Distributed Generation 'Work Plans' that outline progress against improvement initiatives. Check your DNO's Distributed Generation web pages.

Section 3.6: G98 & G99, An Overview of Getting Connected

In this section

- Additional tasks in the process of getting connected
- Guidance on where to find more information

Getting Connected – Energy Storage

Storage devices for electrical energy are becoming more prevalent and can be used as part of Distributed Generation schemes to allow generated electricity to be stored within the premises rather than exported to the distribution network. Storage can also be used to provide ancillary services to network operators. DNOs treat storage as demand when its importing from the distribution network and generation when its exporting to the distribution network and need to be aware of storage because of the potential impact on their networks. Therefore, storage needs to meet the relevant connection requirements (EREC G98 or G99).

If you are planning to use storage in conjunction with PV (or other technologies) to offset consumption, the total connected generation is likely to be above 16A / phase and G99 applies. However, DNOs have implemented a fast-track application process (last revised November 2022), for domestic scale storage. This involves submitting the G99 Form A1-2: Application for connection of Fully Type Tested Generation under the Small Generation Installation Procedure and reduces the time for the DNO to provide confirmation that the connection is acceptable from 45 days to 10 days or less. If the storage is intended to be operated in island mode (during a power outage) the fast-track process is not applicable and the standard G99 process applies. Further information can be found [here](#).

As part of the standard application form you will be asked to provide the following information:

- Information about Energy Storage System (ESS) installer / Operator.
- Details about the storage type (storage only / combined with another technology), storage technology, rating of storage, storage capacity and information regarding import and export capacities.
- Details of operating modes/ commercial service as well as additional operational details.

In addition to the above, the ENA has been working with Ofgem and the DNOs to develop ‘Tactical Solutions’ that can be implemented quickly by working within existing code and licence requirements. These are designed to get better use of the existing network capacity and avoid triggering unnecessary reinforcements. The new solutions went live from 30 September 2023. It is recommended visiting the ENA to website to understand the changes. This can be found here - [Battery Storage Connections - Tactical Solutions Guidance Notes – Energy Networks Association \(ENA\)](#).

Energy Storage operation:

The DNO will undertake system design studies to assess the voltage step change based on the storage worst-case power swing considering Active Power and Reactive Power. As it is unlikely that both parameters will change simultaneously an accurate representation of the storage operation should be provided in the Standard Application Form (SAF) to allow the DNO to undertake a representative assessment.

Before any change is made to the operating arrangements of the storage, a modification to the Connection Agreement must be formally requested so that the DNO can assess the capacity of the distribution system to accommodate the revised operating regime.

Getting Connected – EREC G98 Exceptions

EREC G98 exceptions

If you are installing a generating unit under EREC G98 / G99 then the requirements apply in full in most circumstances. However, if your generating unit is one of the following, some of the technical requirements in EREC G98 / G99 do not apply:

- Classified as an Emerging Technology (see Emerging Technology box on page 7)
- An electricity storage device commissioned before 01 September 2022
- Has a registered capacity of < 800 W
- Operating in infrequent short term parallel operation mode (i.e. operates in parallel with the distribution network no more than 5 minutes in any month, and no more frequently than once per week)

The full details of the requirements that do not apply are in EREC G98/G99.

If you are installing generating units that are connected via an inverter, the 800 W threshold applies to the aggregate installed capacity of generation. So, for example, if you are installing 3 x 500 W solar PV inverters, the aggregate installed capacity exceeds 800 W and EREC G98 applies in full.

It should be noted that there is likely to be a new requirement for Electricity Storage devices. This would mean in the event of a system frequency event, if a storage device is operating in an import mode it would need to switch to an export mode. The specifics of the requirement are being considered by a NGENSO working group. It is currently expected that the working group will conclude during 2022.

Getting Connected

Supply issues

Your DNO is obligated to maintain the power quality on their network within a set of defined limits. These include maintaining voltage at the required levels. This is so that customer equipment is not damaged. If you have a voltage complaint you should contact your DNO. Your DNO should respond to your complaint within 5 working days, or visit within 7 working days. If work is required to correct the issue, the DNO should complete this within 6 months.

Health and safety considerations

Safety is very important in the design of generation connections. Some of the safety requirements for Distributed Generation connections are set out in EREC G98. This document references the Regulation that informs these requirements, the Electricity Safety, Quality and Continuity Regulations (ESQCR) 2002, and lists the relevant British Standards.

You can find out more about Health and Safety aspects of Distributed Generation connections on the following websites:

- The Electrical Safety First (ESF): <https://www.electricalsafetyfirst.org.uk/>
- The Energy Networks Association—Safety, health and environment: <https://www.energynetworks.org/keeping-you-safe/commitment-to-public-safety>

Getting Connected – Vehicle to Grid

Vehicle to Grid (V2G) is in its infancy and trials are being undertaken to further understand and demonstrate its benefits. For V2G the electric vehicle will be considered as both a demand and a generator by DNOs. The application you need to submit will depend on the power export capacity of the V2G unit and what generation or storage devices are already connected at the designated charging point. It is likely that V2G will be > 16 A/phase and therefore G98 is not applicable and G99 should be used.

The current situation is that installers follow one of two generation application processes and sets of forms, which are as follows below:

- Where the total of all generation, fixed storage and the power export capacity of the V2G is < 50 kW 3-phase or 17 kW single-phase, the G99 Simplified Application Form A1-1 can be used.
- Where the total of all generation, fixed storage and the power export capacity of the V2G is > 50 kW 3-phase, the connection application should be made using the Standard Application Form.

In addition, your installer should complete forms associated with a standard Electric Vehicle (EV) charge point, such as the ENA EV installation form (“Application Form for the Installation of Low Carbon Technologies”). The DNO may request further information, such as a photograph of your electric meter and consumer unit.

The ENA Low Carbon Technology Working Group has been looking at ways to simplify the connection application process and associated forms for V2G applications, including considering a single process that combines the aspects of EV as demand and generation. This is now available and an updated version was published on the 7th July 21. The form is available at the [ENA website](#) under the heading “Connecting electric vehicles (EVs) and heat pumps”.

Where to Find More Information

If you want to find out more, these documents are particularly relevant:

- [Engineering Recommendation G98](#): Requirements for the connection of Fully Type Tested Micro-generators (up to and including 16 A per phase) in parallel with public Low Voltage Distribution Networks on or after 27 April 2019. This can be downloaded free of charge via the [DCode](#) as well as ENA website.
- [Electricity Safety, Quality and Continuity Regulations \(ESQCR\) 2002, Section 22](#): Statutory Instrument Number 2665, available free of charge.
- Ofgem’s information about [how to get an electricity connection](#) for a new building or site.

Some DNOs have produced their own guidance notes for small scale Distributed Generation connections - check your DNO’s website.

Other useful documents and links

- Independent Connections Providers (ICPs): see the [Lloyds Register](#) website information on the National Electricity Registration Scheme (NERS)
- [Metering Codes of Practice](#)
- The [IET Wiring Regulations](#) (British Standard 7671) are available to buy on the IET website
- Ofgem’s information about [how to get an electricity connection](#) for a new building or site

Dealing with disputes

If you are not satisfied with a particular aspect of service during the process of connecting your generation, your first port of call should be the party with whom the issue lies, e.g. The DNO, supplier, etc. DNOs have their complaints process set out on their websites. If you still cannot resolve the issue you can contact the Energy Ombudsman: <https://www.ombudsman-services.org/>

If you are still unable to resolve the matter, as a last resort it can be referred to Ofgem.

Manufacturers’ Information

Manufacturers’ information is a term used in EREC G99. Along with Type Testing and onsite tests, it is another way of demonstrating compliance of a Power Generating Module with EREC G99 by providing information. The information is supplied by the manufacturer to the customer, who should send it to the DNO. The suitability of

the information is agreed between the generator and the DNO. Once the DNO is satisfied that the manufacturers' information they have received accurately represents the performance of the generating unit, it may be assigned a reference ID. If your generating unit already has manufacturers' information available and a reference ID, you can use this reference ID in your compliance forms.

Section 4: The Connection Application Process

This section discusses the connection application process for all distributed generation connection types.

Section 4.1: G98 Single Premises, The Connection Application Process

In this section:

- What the installer of your generating unit needs to do to notify the DNO that your generation has been installed and commissioned in accordance with EREC G98
- Details of the information that you will need to provide to the DNO.

Introduction

Under the provisions of the Electricity Safety, Quality and Continuity regulations (ESQCR) you only need to inform the DNO that you have installed your generating unit. You do not need to contact the DNO in advance if the total capacity of all your generating units combined is 16 Amps or less per phase at low voltage.

This section of the Guide summarises the information which you will need to provide to your DNO and gives information about the forms that are used for providing the necessary technical details.

The Installation Document

You do not need to talk to your DNO before your generation equipment is up and running. Your installer must inform the DNO and provide a number of pieces of information **within 28 days of the date of commissioning**. This information is defined in a Installation Document, which is provided in Appendix 3 of EREC G98. This can be accessed at [Energy Networks Association website](#).

Your installer should prepare all of the details requested in the installation document and submit all this with the form to confirm that your equipment has been commissioned. The information required includes:

- details about the **site** where you are connecting your generating unit, including metering information;
- **contact details** for the owner of the generating unit;
- **technical information** about the generating unit itself, including the generating capacity, type test reference and primary energy source;
- details of the **installer** of the generating unit, including the party's accreditation and qualifications;
- **supporting information**, eg. Circuit diagrams; and
- a **signed declaration** as to the compliance of the generating unit with the requirements of EREC G98.

Other Requirements

The declaration that your installer signs on the Installation Document requires them to confirm that they've installed your generating unit in accordance with EREC G98. It's important that you use an installer who is familiar with the requirements of these standards. If you appoint a competent installer (see [Section 3: An Overview of Getting Connected](#)), they should know about these standards and make sure that your installation meets with all the relevant standards. You should check that your installer is aware of all these requirements.

Section 4.2: G98 Multiple Premises, The Connection Application Process

In this section:

- How to apply to your DNO for connecting generating units in multiple premises
- Details of the information that you will need to provide to the DNO and the design work they may need to do to assess your connection
- How to notify the DNO that your generation unit(s) has been installed and commissioned in accordance with EREC G98

Introduction

This section of the Guide describes how to inform your DNO that you are planning to install a number of generating units that fall under EREC G98 into different customer sites within a close geographic region. This section also explains the notifications which the installer of your equipment will need to give to your DNO once the units are commissioned.

The Application for Connection Pro-forma

The Application for Connection Pro-forma included in EREC G98 should be completed by your installer if you are planning to install generating units covered by EREC G98 in different customer sites within a close geographic region. This should be submitted **before any generation is installed**, as the DNO needs to assess the possible impact of your generating equipment on the distribution network. The format for the application is shown in Form A in Appendix 3 of EREC G98. This can be accessed at [Energy Networks Association website](#).

The form requires a number of pieces of information:

- details of the **installer** of the generating units, including their qualifications; and
- **information on the proposed equipment**, including the address, meter number, capacity, and type testing reference number.

When the application has been submitted to the DNO by your installer, the DNO will assess the impact of the generation on their network. Where necessary, they will carry out design work, e.g. for network reinforcement. As mentioned, if your generation project is part of a larger project, e.g. developing new housing, then your application needs to be coordinated with the connection application for import supplies. Connection of the generation equipment will only be allowed to proceed after the DNO has approved the application, and any facilitating works for the connection have been completed.

Installation and Commissioning

If the DNO gives permission for the installation of your generation equipment to proceed, your installer will install and commission the generating units. They must then notify the DNO that this has been done, in accordance with the Electricity Safety, Quality and Continuity Regulations (ESQCR). The process and timescales for doing this are described below.

The Installation Document

The installer of your generating units has to tell the DNO about each generation installation **within 28 days of the date of commissioning** (including the commissioning day itself).

The Installation Document in EREC G98 is a convenient way of capturing all the information that the DNO needs to know once your installer has commissioned each of your generating units.

This can be found in Form B in Appendix 3 of EREC G98. This can be accessed at [Energy Networks Association website](#).

The information required includes:

- details about the **site** where you are connecting your generating unit, including metering information;
- **contact details** for the owner of the generating unit;
- **technical information** about the generating unit itself, including the generating capacity, type test reference and primary energy source;
- details of the **installer** of the generating unit, including the party's accreditation and qualifications;
- **supporting information**, e.g. Circuit diagrams; and
- a **signed declaration** as to the compliance of the generating unit with the requirements of EREC G98.

One installation document is required for each generating unit.

Other Requirements

The declaration that your installer signs on the Installation Document requires them to confirm that they've installed your generating unit in accordance with EREC G98. It's important that you use an installer who is familiar with the requirements of these standards. If you appoint a competent installer (see [Section 3. An Overview of Getting Connected](#)), they should know about these standards and make sure that your installation meets with all the relevant standards.

Section 4.3: G98 Single & Multiple Premises, The Connection Application Process

Getting Connected – Guidance on Compliance

ENA Type Test Register

In order for a generating unit to be registered in the test type register, the manufacturer will need to complete a Type Test Verification Report, which demonstrates that the generating unit complies with EREC G98 or G99 requirements. **Once complete, the Type Test Verification Report should be uploaded and maintained on the ENA's Type Test Register by the generating unit manufacturer.** The ENA Register gives assurance to DNOs / IDNOs that the generating unit connected to their network is fully compliant with EREC G98 or G99 procedures. The ENA Type Test Register also gives assurance to customers and installers that equipment is suitable to be connected and operated in parallel with a network. When details on a new generating unit, or amendments to an existing generating unit, are submitted to the ENA Type Test Register, it is assigned an 'Awaiting Assessment' compliance status. It can take up to 4 weeks for the compliance status to be assessed. Once the ENA compliance assessment is complete, one of the following compliance statuses will be assigned:

- **Compliant:** The generating unit has been reviewed against EREC G98 or G99 requirements and is deemed compliant. This is indicative only and the DNOs retain the right to review the suitability of connecting the generating unit to their network.
- **Minor Non-compliance or Document Error:** The generating unit cannot be accepted as compliant due to documentation errors or the need for additional further information or assessment to ensure compliance with EREC G98 or G99. Once the documentation has been updated by the manufacturer, it will be reviewed again.
- **Non-compliant:** The generating unit is deemed, based on the submitted evidence, or lack of it, to be noncompliant and requires a revision and update of the information. Noncompliant generation must not be connected in parallel with the network and must resubmit their evidence to the ENA.

The ENA provides compliance guidance on their Type Test Register website to support manufacturers with:

- Providing the right information in their Type Test Verification Report; and
- Confirming compliance after the ENA's review of the evidence against EREC G98 or G99 requirements.

Key information on the ENA Type Test Register website is summarised below:

- A PowerPoint webinar presented at a manufacturers' workshop on 03 November 2020. This provides an example walkthrough of the EREC G98 Form C (Type Test Verification Report) for a 3 kW Energy Storage Device, with tips on how to record the right information in the form. The webinar slides contain examples of compliance and non-compliance, including typical errors seen in Type Test Verification Reports. The link to the PowerPoint slides can be accessed via the ENA Type Test Register: <https://www.ena-eng.org/gen-ttr/>
- A user guide on the ENA Type Test Register <https://www.ena-eng.org/gen-ttr/UserGuide/userguide.pdf>
- Further information on EREC G98/G99 guidance forms: https://www.ena-eng.org/gen-ttr/UserGuide/G98_G99_Guidance_Forms.pdf

Common errors on EREC G98 Form C (Type Test Verification Report) forms

- Incorrect declaration to EREC G98 (i.e the registered capacity exceeds the 16 A per phase threshold for EREC G98);
- Confirmation of logic interface is missing;
- Issues with voltage fluctuations / flicker;
- Partially Weighted Harmonic Distortion (PWHD) / Total Harmonic Distortion (THD) values not provided;

Section 4.3: G98 Single & Multiple Premises, The Connection Application Process

- Missing 2nd and 3rd harmonic current values;
- Harmonic current calculation incorrect;
- Fault level contribution missing; and
- Limited Frequency Sensitive Mode— Overfrequency (LFSM-O) active power output does not reduce with the required droop

Section 4.4: G99 Type A, The Connection Application Process

In this section:

- How to apply to your DNO to install Power Generating Modules
- Details of the connection offer that the DNO will produce for your connection
- How to notify the DNO that your Power Generating Modules have been installed and commissioned in accordance with EREC G99

Introduction

This section of the Guide describes the application process for the connection of your Power Generating Modules to the distribution network. This includes the application for connection form, and the connection offer from the DNO.

This section also explains the forms that your installer will need to provide to the DNO, including:

- compliance forms, and
- notifications once the units are commissioned.

This section is written for installations where the Power Generation Module to be installed is categorised as being Type A in EREC G99, and where the output is greater than 16A per phase. If this does not apply to your installation, please refer to Table 2, Table 3, Table 7 in the section at the beginning of this guide entitled “Is this the right Guide for my project?”.

There is more information on the connection application process in the Section for EREC G99 Type B – D Power Generating Modules, including:

- Wayleaves for new connections;
- Interactive connection applications; and
- The Statement of Works process and recent developments in this area.

These are unlikely to be relevant for connecting Type A Power Generating Modules, but if these do impact your project, refer to the EREC G99 Types B to D Guide for more detailed information on these topics.

The Standard Application Form

For Power Generating Modules with capacity less than 50 kW 3-phase or 17 kW single phase there is a simplified connection application form in [Annex A.1 of EREC G99](#), which is available from the ENA website. This form is simpler than the form required for larger Power Generating Modules. It requires information about the site, any existing generation on the site, and some simple details of the equipment you are intending to install.

For larger Power Generating Modules there is a standard application form, which is available on the ENA website and generally on DNO websites.

The standard application form contains a comprehensive list of data requirements to assist the DNO with carrying out system studies to assess your connection. You should do your best to provide as much of this information as possible as part of your connection application to ensure your quote is as accurate as it can be. If you have difficulty with filling out this form, you can discuss this with your DNO or an adviser such as an engineering consultant to assist you.

You or your installer should submit the application form to the DNO before any generation equipment is installed, as the DNO needs to assess the possible impact of your generating equipment on the distribution network.

The standard application form is used as an iterative document, developed as the connection and commission process develops. It is used to record information about your generating units that needs to be provided to the DNO before commissioning, to comply with the requirements set out in the Distribution Code DDRRC.

When the application has been submitted to the DNO, they will assess the impact of the generation on their network. Where necessary, they will carry out design work, eg. for network reinforcement. This will be detailed in your Connection Offer.

The Connection Offer

The Connection Offer that you will receive from your DNO should contain a number of key pieces of information. These include:

- details of the equipment and works needed to connect your generating units to the distribution network;
- information about any works needed to extend or reinforce the DNO's network as a result of connecting your generating unit to the system;
- any technical and commercial terms which will apply for the DNO to construct the connection and provide Use of System services to the developer;
- Any other useful information such as whether the DNO will need to witness commissioning of your units.

The offer will also contain details of the costs for the DNO to undertake any work. Further information about these costs is given in [Section 5: Costs and Charges](#). You will have a defined period specified in your Connection Offer within which to accept the offer. This will typically be in the range 30- 90 days. Make sure you are aware how long your acceptance period is, as this can vary across DNOs. There is no guarantee that once a connection offer is lapsed that a similar offer can be made again.

Connection Offers may also be withdrawn if the DNO feels that your plant is not progressing at a reasonable rate. This may be measured by progress against milestones set out in your Connection Offer. This is to prevent spare capacity being 'reserved' for projects that in practice are not actually being built. Your DNO may specify reasonable milestones to be met to prove the progress of your project.

It is possible that there will be other Distributed Generation in development in the same area of the network. If this is the case, your application may affect, or be affected by, another connection application. In this case all the relevant applications are referred to as "interactive". The DNO will tell you in writing if your connection application is interactive with one or more others. The Connection Offer will also specify that it is interactive with other applications.

Interactive connection applications are considered on the basis of 'first come first served'. The DNO uses the date and time that your Connection Application was made to put your Connection Offer in priority order compared to other applicants. For more information on interactive applications, see the EREC G99 Types B to D Guide.

Connection Conditions

The DNO may include certain conditions or restrictions in order for the connection to be put in place. Your Connection Offer will include details of these, and if you need to know more information then you can discuss this with your DNO. You will have to agree to these conditions in order to accept the Connection Offer.

Flexible Connection Offers

The DNO will decide if a connection is viable by considering the worst-case scenario for the network. If the connection of your generation would cause equipment ratings or statutory limits to be exceeded, then the DNO would not allow the connection without addressing the issues identified. The DNO may decide that the best thing to do is to reinforce the existing network so that it can cope with new power flows. However, this could be prohibitively expensive for your project.

In these cases, or where the customer has requested, the DNO may offer a connection with certain restrictions, such as setting a maximum level for export, or restricting generation export under certain network conditions. This could involve entering into a specific commercial arrangement.

For connection applications after 1 April 2023 the DNO may offer a curtailable (non-firm) connection to allow a quicker connection to the network. This will include an agreement that your connection may be restricted at certain times. The amount of curtailment will be measured and compared against an agreed limit above which the DNO will pay you compensation. The curtailment will cease after an agreed end date by which time the necessary network reinforcement should have been made. See section 5.5 Connection Charges for more information.

Even with a standard Connection Agreement, in rare operational scenarios it may be necessary for the DNO to curtail the operation of a generator in order to, for example, maintain safety or power quality.

If NGENSO is involved in your project (e.g. if your DNO has requested a Statement of Works for any transmission system works required), then they can impose conditions on your connection. Your DNO must ensure that NGENSO conditions are met before they allow connection.

Reactive Power Import / Export

The apparent power at any point on the network is the product of the voltage and current at that point. The apparent power is made up of two components, the active power and the reactive power. It is likely that active power is the electrical power you are more familiar with. It is measured in Watts (W) and is the useful power that we import into our houses to run our electrical goods. However, there also needs to be a balance of reactive power on the network. It is the DNO's responsibility to ensure that the distribution network can cater for both real and reactive power. Your generating unit will be capable of controlling the amount of reactive power that it absorbs or produces. All PGMs need to comply with G99 reactive power capabilities. It may be possible to mitigate negative effects that your generator might have on the network (e.g., rise in system voltage) by controlling the amount of reactive power you produce or absorb. This may allow you to connect a higher capacity generator. You can discuss this option with your DNO.

Compliance Forms

If your Power Generating Module is Fully Type Tested and registered with the Energy Networks Association (ENA) online Type Test Verification Report Register, it will have a manufacturer's reference number (or Product ID on the ENA website). This means that the Power Generating Module meets the requirements of EREC G99, and the manufacturer has submitted information to the ENA that demonstrates this. You should include the reference number on your application form, and do not need to submit anything further to demonstrate compliance.

Otherwise, your Power Generating Module may comprise a mixture of type tested components, components where the compliance is demonstrated using manufacturers' information, and components that will need to be tested on site. In this case you (or your installer) need to submit information to indicate how you are intending to demonstrate compliance with EREC G99. This is done by submitting a Compliance Verification Report for each Power Generating Module. The format of this report is given in Appendix A.2 of EREC G99. There are several options ([Forms A.2-1](#), [A.2-2](#), [A.2-3](#)), depending on the size of your Power Generating Module, and the type (synchronous, asynchronous, inverter connected). These forms should be submitted prior to arranging commissioning.

In some cases (e.g. where interface protection is not Type Tested) you will need to demonstrate elements of compliance on site. You can do this at the time of commissioning (see below). In this case, there is a [Form A.2-4](#) in EREC G99 called "Site Compliance and Commissioning test requirements for Type A Power Generating Modules", which sets out the format of recording the relevant test results. Where the DNO witnesses commissioning, this can be submitted to the DNO on the day. Otherwise, this should be submitted to the DNO within 28 days.

The Installation Document

Commissioning should take place once the installation and connection is complete (or in the case of a phased installation, when the phase is complete). The tests and checks required for commissioning are described in section 15 of EREC G99.

The results of the commissioning should be recorded on the Installation Document, which is included in Annex A.3 in EREC G99, available on the ENA website.

You or your installer should fill out this form and sign the declaration at the bottom. The information required includes:

- details about the site where you are connecting your generating unit, including metering information;
- contact details for the owner of the generating unit;
- technical information about the power generating unit itself, including the generating capacity, type test reference and technology type;
- details of the installer of the power generating module, including the party's accreditation and qualifications;
- supporting information, eg. Circuit diagrams; and
- a signed declaration as to the compliance of the power generating module with the requirements of EREC G99.
- a signed declaration as to the compliance with the site compliance and commissioning tests, if applicable (Form A2.-4).

There are two parts to the Installation Document:

- Part 1 is required for the Power Generating Facility; and
- Part 2 is required for each Power Generating Module.

The Installation Document must be submitted within 28 days of the date of commissioning (including the commissioning day itself). If the DNO witnesses the installation, then the form can be filled in on the day and handed to the DNO representative.

Other Requirements

The declaration that your installer signs on the Installation Document requires them to confirm that they've installed your generating unit in accordance with EREC G98. It's important that you use an installer who is familiar with the requirements of these standards. If you appoint a competent installer (see [Section 3: An Overview of Getting Connected](#)), they should know about these standards and make sure that your installation meets with all the relevant standards. You should check that your installer is aware of all these requirements.

Section 4.5: G98 Multiple Premises & G99 Type A, The Connection Application Process

Getting Connected – Guidance on Compliance

ENA Type Test Register

In order for a generating unit to be registered in the test type register, the manufacturer will need to complete a Type Test Verification Report, which demonstrates that the generating unit complies with EREC G98 or G99 requirements. **Once complete, the Type Test Verification Report should be uploaded and maintained on the ENA's Type Test Register by the generating unit manufacturer.** The ENA Register gives assurance to DNOs / IDNOs that the generating unit connected to their network is fully compliant with EREC G98 or G99 procedures. The ENA Type Test Register also gives assurance to customers and installers that equipment is suitable to be connected and operated in parallel with a network. When details on a new generating unit, or amendments to an existing generating unit, are submitted to the ENA Type Test Register, it is assigned an 'Awaiting Assessment' compliance status. It can take up to 4 weeks for the compliance status to be assessed. Once the ENA compliance assessment is complete, one of the following compliance statuses will be assigned:

- **Compliant:** The generating unit has been reviewed against EREC G98 or G99 requirements and is deemed compliant. This is indicative only and the DNOs retain the right to review the suitability of connecting the generating unit to their network.
- **Compliant – on-site confirmation by DNO Required:** The generating unit and its key documentations has been reviewed against EREC G98 or G99 and the device is compliant if confirmed onsite by the DNO. This would apply for any compliance tests that have been identified in Form A2-1, Form A2-2 or Form A2-3 as being undertaken on site such as power quality assessment. No further action is required by the manufacturer.
- **Minor Non-compliance or Document Error:** The generating unit cannot be accepted as compliant due to documentation errors or the need for additional further information or assessment to ensure compliance with EREC G98 or G99. Once the documentation has been updated by the manufacturer, it will be reviewed again.
- **Non-compliant:** The generating unit is deemed, based on the submitted evidence, or lack of it, to be noncompliant and requires a revision and update of the information. Noncompliant generation must not be connected in parallel with the network and must resubmit their evidence to the ENA.

The ENA provides compliance guidance on their Type Test Register website to support manufacturers with:

- Providing the right information in their Type Test Verification Report; and
- Confirming compliance after the ENA's review of the evidence against EREC G98 or G99 requirements.

Key information on the ENA Type Test Register website is summarised below:

- A PowerPoint webinar presented at a manufacturers' workshop on 03 November 2020. This provides an example walkthrough of the EREC G98 Form C (Type Test Verification Report) for a 3 kW Energy Storage Device, with tips on how to record the right information in the form. The webinar slides contain examples of compliance and non-compliance, including typical errors seen in Type Test Verification Reports. The link to the PowerPoint slides can be accessed via the ENA Type Test Register: <https://www.ena-eng.org/gen-ttr/>
- A user guide on the ENA Type Test Register <https://www.ena-eng.org/gen-ttr/UserGuide/userguide.pdf>
- Further information on EREC G98/G99 guidance forms: https://www.ena-eng.org/gen-ttr/UserGuide/G98_G99_Guidance_Forms.pdf

The different compliance forms (A2-1, A2-2, A2-3), which are relevant to your PGM are illustrated in the diagram below.

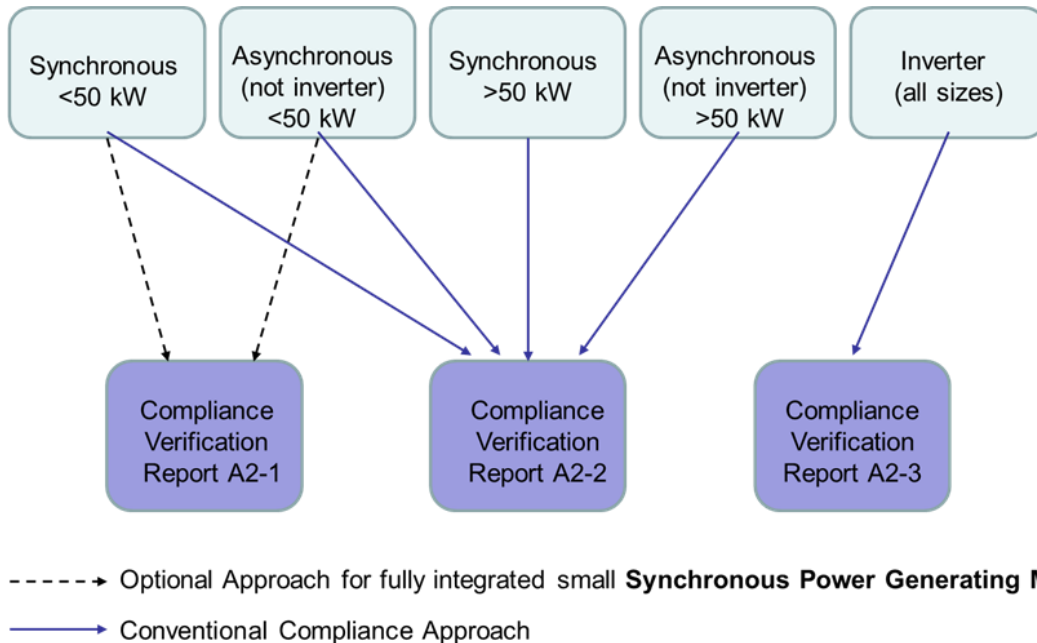

Figure 10: Diagram showing the different compliance forms.

Type Test options

A layout of the EREC G99 A2-3 (Verification Report for Type A Inverter Connected Power Generating Modules) form is provided below. This form is for inverter connected generation and is the most commonly used of all the Type A Power Generating Module compliance forms. The form can be used to demonstrate compliance of:

1. Fully type tested Power Generating Modules (≤ 50 kW); all tests should be complete;
2. A type tested product (part of a Power Generating Module such as a Generating Unit, Inverters and the Interface Protection) with test results;
3. One-off Installation where the Manufacturer or Installer can confirm that the Power Generating Module has been tested to satisfy all or part of the requirements in EREC G99
4. A Power Generating Module where elements are to be tested on site during the commissioning.

Columns 2 – 4 of the table in Figure 11 below should be used to indicate (e.g., with ticks) which tests are being demonstrated in the form.

Common errors on forms

Examples of common errors in the EREC G99 Form A2-3 (Compliance Verification Report for Type A Inverter Connected Power Generating Modules) are as follows:

- Confirmation of logic interface is missing;
- Issues with voltage fluctuations / flicker;
- Partially Weighted Harmonic Distortion (PWHd) / Total Harmonic Distortion (THD) values not provided;
- Missing 2nd and 3rd phase harmonic current values;

Section 4.5: G98 Multiple Premises & G99 Type A, The Connection Application Process

There are four options for Testing: (1) **Fully Type Tested**, (2) **Type Tested** product, (3) one-off installation, (4) tested on site at time of commissioning. The check box below indicates which tests in this Form have been completed for each of the options. With the exception of Fully Type Tested PGMs tests may be carried out at the time of commissioning (Form A2-4).
Include reference(s) for **Manufacturers' Information** including the ENA Type Test Verification Report Register Product ID number where applicable.

Tested option:	1. Fully Type Tested	2. Type Tested product	3. One-Off Manufactures' Info.	4. Tested on Site at time of Commissioning
0. Fully Type Tested - all tests detailed below completed and evidence attached to this submission		N/A	N/A	N/A
1. Operating Range	N/A			
2. PQ – Harmonics				
3. PQ – Voltage Fluctuation and Flicker				
4. Power Factor (PF)				
5. Frequency protection trip and ride through tests				
6. Voltage protection trip and ride through tests				
7. Protection – Loss of Mains Test, Vector Shift and RoCoF, Stability Test				
8. LFSM-O Test				
9. Power Output with Falling Frequency Test				
10. Protection – Reconnection Timer				
11. Fault Level Contribution				

Figure 11: Testing options on form.

Harmonic current calculations incorrect; Fault level contribution missing; and Limited Frequency Sensitive Mode – Over frequency (LFSM-O) active power output does not reduce in the required droop range

Power Quality assessments

Power quality assessments are required, as per EREC G5 and P28, in relation to harmonics and voltage fluctuations. Generation equipment should not result in harmonics exceeding recommended limits or significant variations in grid voltages outside the limits set out in EREC G5 and EREC P28 respectively. An assessment of compliance with EREC G5 and P28 is necessary for Fully Type Tested devices < 50 kW, however this will generally allow the connection of a Fully Type Tested device with no need for mitigation (unless the fault level is unusually low, e.g., in remote rural locations). Fully Type Tested status cannot be obtained for power generating modules with a capacity > 50 kW, due to the need for site specific compliance assessments with EREC G5 and EREC P28.

Section 4.6: G99 Type B-D, The Connection Application Process

In this section:

- Details of the key stages in the process of making a connection application and receiving a response from the DNO
- Details of the information that you will need to provide to the DNO and the studies that they will need to carry out to assess your application
- Information about what a Connection Offer typically contains
- Information on additional forms and notifications required by EREC G99

Introduction

This section of the Guide describes how to make a connection application to a DNO. It focuses on some specific actions that you will need to take as part of the overall process of “Getting Connected”, which is described in Section 3 of the Guide.

Details of the connection application itself are provided, with reference to the standard application form. The timescales involved in making a connection application are described, although these can vary significantly from one project to another.

This section also includes details of the sort of technical studies which DNOs need to carry out, and the likely requirements they will have for data from you about the proposed generation project.

The Connection Application Timeline

The timeline shown on the next page is an **indicative** guide as to how long it might take you to have a Connection Offer agreed with your DNO. The information box in [Section 4.4: The Connection Offer](#) summarises the licence obligations of the DNO to give you a Connection Offer within a particular time, once you have provided all the necessary data supporting your application.

The times shown in the timeline could vary depending on, for example:

- how quickly you are able to do the background work;
- how complex your connection is; and
- any technical or planning issues that the DNO identifies.

For more information about the information needed by DNOs at different stages in the connection process, see the Distribution Data Registration Code in the Distribution Code. This is available from <https://dcode.org.uk/the-gb-distribution-code-review-panel.html>

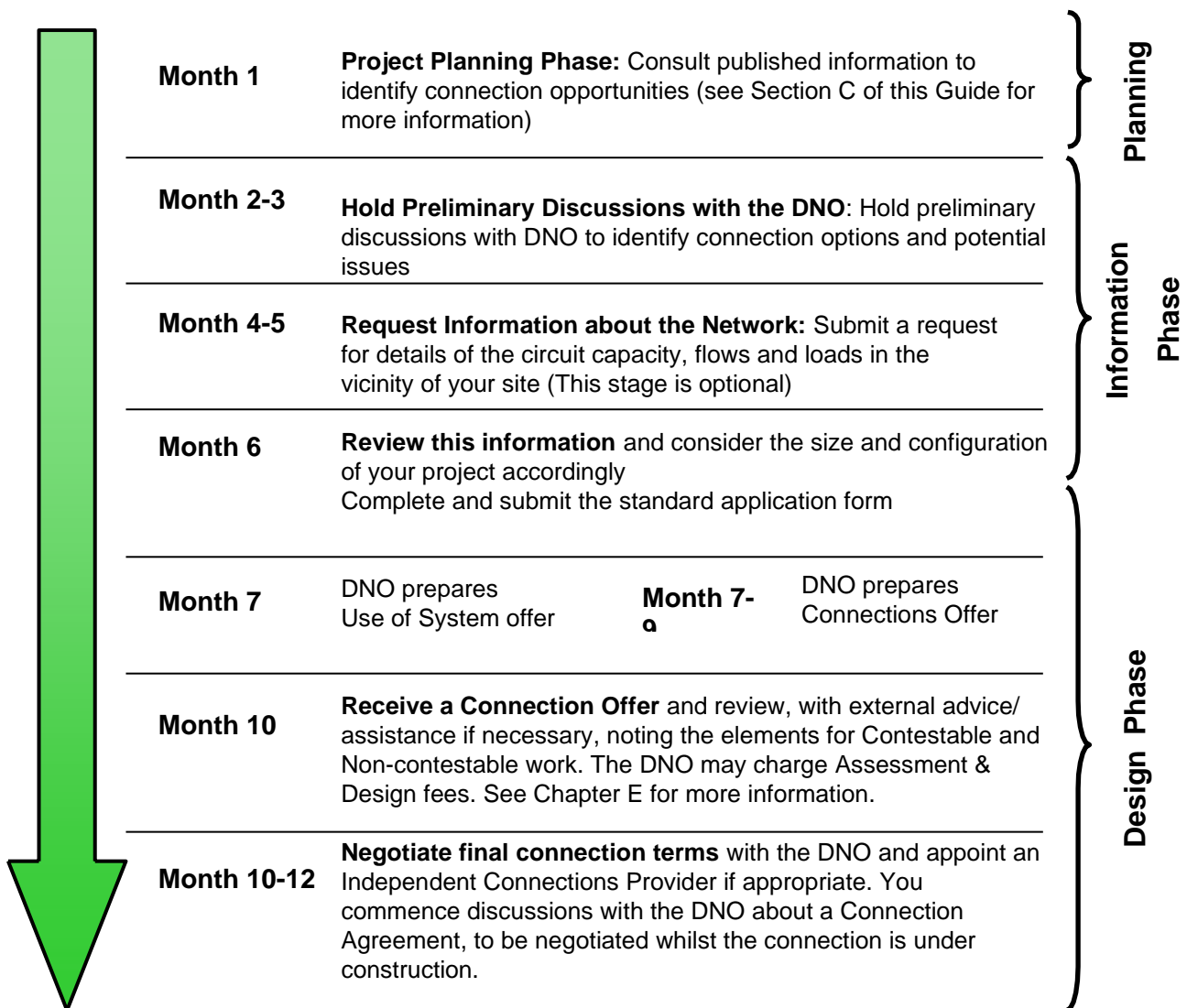

Figure 12: The connection application timeline.

Notes on the timeline:

Some of the stages shown in the timeline are optional, for example, consulting the published information and obtaining advice regarding preliminary connection designs. These activities can be useful as they provide extra information earlier in the process, and they may uncover issues earlier than they would otherwise be known, allowing them to be planned for. If you do not undertake these activities but are happy to lodge a formal connection application after an initial discussion with your DNO, the time to complete this process will be reduced.

It is also possible to combine some of the stages of activity, so that for example you begin compiling the information to support your connection application whilst in the early stages of discussions with the DNO. This would reduce the elapsed time in the connection process from what is shown above.

If your generation project might have an impact on the transmission network, the above timescale could be significantly extended, due to the need to obtain a Statement of Works from NGENSO regarding any required transmission system modifications. You should discuss the likelihood of a Statement of Works being required with your DNO at an early stage.

Initial Discussions with the DNO

To make applying for a connection as straightforward as possible, you are advised to contact your DNO at an early stage in the connection process. You should explain to them in as much detail as you can the plans that you have in mind, so that they can give you an early indication of the likely technical challenges and/or significant cost items which may be required to make your connection possible. If you think you will have import requirements (most generation projects have a least a small import requirement to cater for when the Power Generating Facility is not running), these should be discussed with the DNO as well as your export capacity requirements. It is likely that the DNO will invite you for an initial discussion, which is usually free of charge. This is the chance for both parties to share information which will be helpful in putting the connection application together. Before you have this discussion, though, it's helpful if you have done some background work to investigate the network in the area around your project, and to be able to provide technical information about your generating equipment.

Information about the Network

To obtain more specific information, however, you can make a request to the DNO for an estimate of the present and future circuit capacity, forecast power flows and loadings on the relevant parts of the distribution network. You may be charged for some or all these services.

The information that the DNO will provide should be sufficient to enable you to identify and evaluate the opportunities for connecting to and using the relevant parts of the DNO's network. It may also, if you so request, include a commentary on the DNO's views regarding the suitability of the relevant part of the distribution network to accommodate new connections and the export of power from the proposed Power Generating Module(s).

You may also wish to request the DNO or a third party (e.g. an engineering consultant) to carry out feasibility studies to identify budgetary connection costs for your proposed project. The reliability of these estimates will be significantly influenced by the quality of the information that you can provide at this time to enable a reasonable assessment of the likely connection configuration and capacity to be carried out. Some DNOs will charge for carrying out these budget estimate and others will not.

Requesting information: This stage is not compulsory—you can proceed with your application form without carrying out this background work. It is up to each developer to decide whether requesting this sort of information is going to be helpful to the overall development of their connection, or whether simply to proceed with the formal application.

The Standard Application Form

You should use the standard application form (or Generator Connection Application Form). This is available free of charge, and can be found on the [Energy Networks Association \(ENA\) website](#).

The standard application form (application form) contains a comprehensive list of data requirements to assist the DNO with carrying out system studies. You should do your best to provide as much of this information as possible to ensure your quote is as accurate as it can be. If you have difficulty with filling out this form, you can discuss this with your DNO or an adviser such as an engineering consultant to assist you. The requirements in the application form are based on the requirements of the Distribution Data Registration Code, which is part of the Distribution Code. This splits the data requirements from Distributed Generation into three categories: Standard Planning Data, Detailed Planning Data and Operational Data. The application form is split into five

parts. Parts 1 to 3 ask for Standard Planning data, and in some cases, this is sufficient for the DNO to complete the connection design and make a connection offer. However, depending on the generation capacity and the location within the network, you will need to complete Part 4 of the application form. If you do not complete this initially, the DNO may ask you to do it later. Part 5 enables you to provide additional data that may be required by the DNO before they issue a Final Operational Notification (FON). Your DNO will tell you if you need to provide this information.

The standard application form is used as an iterative document, developed as the connection and commission process develops, in conjunction with the PGMD. It is used to record information about your generating units that needs to be provided to the DNO before commissioning, to comply with the requirements set out in the Distribution Code DDRRC.

When completed, your application form should be sent to your DNO. Your DNO's contact details can be found on the [membership area](#) of the ENA website. An online application process may be available on your DNO's website.

Part 1 is for information about the **Owner/Operator** of the generation unit(s) and their consultant's details if applicable, as well as details about the facility, including its location.

Part 2 is for information about export and import arrangements.

Part 3 requests some information specific to the generating units that you are planning to use.

Parts 4 and 5 request more detailed information that is specific to the generation technology and equipment that you are planning to use. The information here is quite detailed, and, if your DNO asks you to provide this information, you may require assistance from the proposed suppliers of your generation equipment to fill in all of the details.

Network Studies

Once you have filled in and submitted the standard application form, the DNO will need to assess the impact of your Power Generating Modules on the network. Your project may affect parts of the network that are distant (both geographically and electrically) from it, including at higher voltage levels (e.g. an 11kV connection can impact the 33kV network). It can take some time to identify the impact on the network at higher voltage levels. The DNO will carry out studies which may include:

- **load flow studies**, to work out where the power that you generate will flow on the distribution network and to check that currents and voltages will stay within equipment ratings and statutory operating limits;
- **contingency analysis**, to decide how to configure your connection so that you can continue to generate if one network component is not operating for any reason (eg. maintenance or work on the network, or a fault on a cable circuit);
- **fault level studies**, to calculate how much current would flow out of your generating units in short circuit conditions and to make sure that the system could safely interrupt the higher fault currents on the system once your project is operational;
- in some circumstances, **transient stability studies** may be necessary to determine whether there are going to be specific protection requirements associated with your project;
- studies of disturbances such as **harmonics** and **voltage flicker** - correcting problems such as this could involve the connection of additional equipment and possibly increase connection costs.

The number and complexity of studies that have to be undertaken will vary depending on a number of factors. These include the type and size of your generating units, the complexity and use of the network around your site, and the level of security you want for your connection. An indication of the charges for these studies can often be found in DNO documentation, such as the Long-Term Development Statement, or the Statement of Charging Methodology.

How quickly must the DNO give me a Connection Offer?

The Standard Conditions of the Electricity Distribution Licence require DNOs to offer terms for connection and use of system “as soon as is reasonably practicable” after receiving a request. If you have only asked for Use of System, the DNO must provide an offer within 28 days. If you have requested both Connection and Use of System, the DNO must give you an offer within three months. These times only apply once the DNO has all the information from you that it can reasonably ask for.

Estimated data: If actual data is not available at the time of completing an application form, you may provide a reasonable estimate of the actual data. You should indicate if data is estimated. Where estimated data is submitted to the DNO, and the final data is significantly different from the estimated data, this may affect the validity of the Connection Offer. It is therefore important that the information you provide is as complete and accurate as possible, and that you inform your DNO of any changes to the data as soon as you can.

The Connection Offer

The Connection Offer that you will receive from your DNO should contain a number of key pieces of information. These include:

- details of the equipment and works needed to connect your Power Generating Modules to the distribution network;
- information about any works needed to extend or reinforce the DNO’s network, and potentially the transmission system, as a result of connecting your generating units to the system;
- information about the metering which the DNO may want to install at your site to measure energy exports for operational purposes;
- any special metering, communications or data processing equipment that may be needed at your site to ensure that you and the DNO can comply with any requirements under the Balancing and
- Settlement Code (which you’ll need to comply with if you have a Generation Licence. See [Section 4. The Connection Application: Generation Licensing](#) for more information).

The Offer will contain the technical and commercial terms which will apply for the DNO to construct the connection and provide Use of System services to the developer. The Offer will differentiate between Contestable work and Non-contestable work, if you requested this information.

The Offer will also contain details of the costs which will apply if the DNO undertakes the Non-contestable and Contestable work. Further information about the way these costs are worked out is given in [Section 5: Costs and Charges](#).

Wayleaves for New Connections

Obtaining Wayleaves, or the right of way for new lines and cables to connect your generating equipment to the distribution network, can be time consuming. Wayleaves are generally obtained by the DNO, although they could in some situations be obtained by an ICP.

To understand the wayleave requirements for your connection you should:

- discuss at an early stage with your DNO whether there is a possibility that obtaining the necessary wayleaves could prove contentious
- consider asking the DNO to investigate this in any feasibility studies you may ask them to undertake
- ask the DNO to indicate in the Connection Offer whether your connection costs or timing could be affected by wayleaving and/or planning consent issues, and to itemise the costs included in the quotation for these components
- ask the DNO to consider alternative routes for cables and/or overhead lines, if this could result in simpler planning and wayleaving processes, and to indicate the different connection costs and timescales that may result – for example, cabling along a public highway, whilst being potentially more

expensive than an overhead line, may have fewer wayleaving complications than the overhead line option. Similarly, if the DNO can avoid routes with complex rail or motorway crossings then obtaining wayleaves and developing the connection may be easier and less costly.

Connection Conditions

The DNO may include certain conditions or restrictions in order for the connection to be put in place. Your Connection Offer will include details of these, and if you need to know more information then you can discuss this with your DNO. You will have to agree to these conditions in order to accept the Connection Offer.

Flexible Connection Offers

The DNO will decide if a connection is viable by considering the worst case scenario for the network. If the connection of your generation would cause equipment ratings or statutory limits to be exceeded, then the DNO would not allow the connection without addressing the issues identified. The DNO may decide that the best thing to do is to reinforce the existing network so that it can cope with new power flows. However, this could be prohibitively expensive for your project.

In these cases, or where the customer has requested, the DNO may offer a connection with certain restrictions, such as setting a maximum level for export, or restricting generation export under certain network conditions. This could involve entering into a specific commercial arrangement.

For connection applications after 1 April 2023 the DNO may offer a curtailable (non-firm) connection to allow a quicker connection to the network. This will include an agreement that your connection may be restricted at certain times. The amount of curtailment will be measured and compared against an agreed limit above which the DNO will pay you compensation. The curtailment will cease after an agreed end date by which time the necessary network reinforcement should have been made. See section 5.5 Connection Charges for more information.

Even with a standard Connection Agreement, in rare operational scenarios it may be necessary for the DNO to curtail the operation of a generator in order to, for example, maintain safety or power quality.

If NGESO is involved in your project (e.g. if your DNO has requested a Statement of Works for any transmission system works required), then they can impose conditions on your connection. Your DNO must ensure that NGESO conditions are met before they allow connection.

Reactive Power Import / Export

The apparent power at any point on the network is the product of the voltage and current at that point. The apparent power is made up of two components, the active power and the reactive power. It is likely that active power is the electrical power you are more familiar with. It is measured in Watts (W) and is the useful power that we import into our houses to run our electrical goods. However, there also needs to be a balance of reactive power on the network. It is the DNO's responsibility to ensure that the distribution network can cater for both real and reactive power. Your generating unit will be capable of controlling the amount of reactive power that it absorbs or produces. All PGMs need to comply with G99 reactive power capabilities. It may be possible to mitigate negative effects that your generator might have on the network (e.g. rise in system voltage) by controlling the amount of reactive power you produce or absorb. This may allow you to connect a higher capacity generator. You can discuss this option with your DNO.

Interactive Connection Applications

Sometimes the DNO may be considering your Connection Application alongside others which would have an impact on the same part of the distribution network. It may be the case where it is not possible to connect all of these projects, due to network constraints such as capacity. In this case all the relevant applications are referred to as "interactive", and are treated according to a common set of principles which have been adopted

by all the DNOs. These principles normally apply to generator applications above 1 MVA capacity connected at 11 kV and above. DNOs will, though, apply the same principles in other cases as required.

Connection Applications are defined as “interactive” if offers are made which: make use of the same part of the current or planned future network; or

- have an operational effect on that network; and
- would affect the terms under which connection can be offered to one of the other parties.

The DNO will tell you in writing if your connection application is interactive, or becomes interactive, with one or more others. Affected parties will receive a ‘Notice of Interactivity’, which includes:

- a notice that your Connection Offers/ POC Offers are interactive;
- your respective position in the Interactive Queue, determined by the date on which your Connection Application was received (assuming that the application form was complete with the information required by the DNO). An Interactive Connection Offer is conditional on those higher up the Interactive queue not being accepted;
- the process for accepting Interactive Connection Offers; and
- the dates of the ‘Moratorium Period’ (usually 10 working days) after which you can accept the Interactive Connection Offer.

When the DNO receives an Interactive Connection Offer acceptance, they notify all other affected parties that their Connection Offers are withdrawn. You will then have the option to re-apply or choose to have your original application to be re-considered. In this case the DNO will issue a new Connection Offer. Offers are still considered in the original order within the Interactive Queue.

Accepting a Connection Offer

You will have a defined period specified in your Connection Offer within which to accept the offer. This will typically be in the range 30- 90 days but is likely to be nearer 30 days if your Connection Application was defined as “interactive”. Acceptance periods can vary across DNOs.

If yours was the first of a number of “interactive” applications, you will have priority over subsequent applicants who may receive offers during this time, and this will be explained in your Connection Offer. If you were a later applicant, your offer will indicate that for some of the validity period of the offer it is dependent on the decision of the prior applicant(s) on whether to proceed with their connection(s). Connection Offers will also specify the date on which they become unconditional (because the previous Connection Offer(s) have lapsed).

Connection Offers may also be withdrawn if the DNO feels that your scheme is not progressing at a reasonable rate. This may be measured by progress against milestones set out in your Connection Offer. This is to prevent spare capacity being ‘reserved’ for projects that in practice are not actually being built.

For more information about Connection Offers and Interactive Applications

All DNOs publish documents called their “Statement of Methodology and Basis of Charges for Connection” This sets out in detail the way that each DNO handles Connection Applications and the arrangements DNOs make for dealing with Interactive Applications. These documents are available from each of the DNOs’ websites.

EREC G99 Additional Forms

There are a number of forms or reports that are required to be completed and submitted to your DNO throughout the development of your connection. Some of these are new requirements introduced in EREC G99, as required for the European Network Code Requirements for Generators. These include:

- Power Generating Module Document (PGMD, as discussed in Section 3)
- Results of simulation studies
- Installation and commissioning confirmation form

The submission and review of the PGMD is likely to be an iterative process so it is useful to engage early with the DNO.

Simulation studies

The requirement for simulation studies for Types B, C and D Power Generating Modules is a new one from the Requirements for Generators. You need to submit a report detailing the outcome of studies to demonstrate compliance with a number of technical requirements, such as fault ride through and fast fault current injection. Some studies are generic whilst others relate to the connection point and require DNO information. Refer to EREC G99 Annex B.4 for Type B Power Generating Modules and Annex C.7 for Type C and D Power Generating Modules for more information.

Site compliance and commissioning tests

You may need to demonstrate elements of compliance on site, which you can do at the time of commissioning. There are forms in EREC G99 called “Site Compliance and Commissioning test requirements”, which set out the format of recording the relevant test results. They are available in EREC G99 in:

- Annex B.2 Form B2-2 for Type B Power Generating Modules
- Annex C.2 Form C2-2 for Types C and D Power Generating Modules

These forms should be submitted to the DNO on the day of commissioning.

Installation and Commissioning Confirmation

Commissioning should take place once the installation and connection is complete (or in the case of a phased installation when the phase is complete). The tests and checks required for commissioning are described in section 15 of EREC G99.

The results of the commissioning should be recorded on the Installation and Commissioning Confirmation Form. This is included in EREC G99 in:

- Annex B.3 for Type B Power Generating Modules, and
- Annex C.3 for Types C and D Power Generating Modules

The forms are also available on the ENA [website](#).

You or your installer should fill out this form and sign the declaration at the bottom.

There are two parts to the Installation and Commissioning Confirmation Form:

- Part 1 is required for the Power Generating Facility (ie all Power Generating Modules), and
- Part 2 is required for each Power Generating Module.

The forms should be submitted to the DNO on the day of commissioning.

EREC G99 Notifications

The EU Network Code Requirement for Generators (RfG) introduces a requirement for formal notifications from the DNO.

Type B and C

For Type B and Type C Power Generating Modules the only notification you will receive is a Final Operational Notification (FON). The DNO issues this, as part of the Connection Agreement, when they are satisfied that you have demonstrated compliance with EREC G99. Type B and Type C sites do not have permanent rights to operate until a FON is issued; however, this does not stop the export of energy until the commissioning process is complete and Generators can still gain revenue in advance of being issued FON.

You will not be permitted to operate your Power Generating Module until you have received your FON.

Type D

If you are installing a Type D Power Generating Module there are additional notifications, you need to obtain. Before energising your internal network for the first time, you need an Energisation Operational Notification (EON). You obtain this from your DNO by:

- providing updated information required in the standard application form (or the Distribution Data Registration Code schedules), and
- notifying the DNO that your plant is ready to connect, at least 28 days before you wish to do so.

And then when you want to synchronise your Power Generating Module for the first time you need to obtain an Interim Operational Notification (ION). You obtain an ION by submitting a draft Power Generating Module Document (PGMD). The ION may impose limitations on the maximum allowed output of your plant.

The ION will be valid for a fixed period of time to allow the compliance and commissioning tests to be completed and any unresolved issues to be addressed. If necessary, the ION can be extended, but the maximum length of time that an ION can be used is 24 months.

After 24 months it will be necessary to obtain a derogation from Ofgem.

On resolution of any unresolved issues and formal submission of the completed PGMD and appropriate installation and commissioning forms the DNO will issue a FON which will form part of the Connection Agreement.

If, following issue of an FON, the generating plant is found to be non-compliant with EREC G99 you should notify the DNO and where possible rectify the issue.

If the non-compliance is not resolved within 28 days then you should undertake an investigation in conjunction with the DNO to determine the cause of the non-compliance and identify a solution. If after 56 days of investigations the issue is not resolved then you will be issued with a Limited Operational Notification (LON). You can continue to operate during this period, taking account of the operational restrictions in the LON. The LON will also list the unresolved issues.

You may also be issued with a LON if you modify your plant in such a way as to result in a change of performance. You will need to submit new data and a PGMD to demonstrate compliance with EREC G99.

The LON can last for up to 12 months. After 12 months you, in conjunction with the DNO, must apply to Ofgem for a derogation in order to obtain a FON if you are unable to demonstrate full compliance with EREC G99.

If a derogation is not granted then you will not be able to continue to operate the Power Generating Module.

Section 4.7: G99 Type B-D, The Connection Application Process – Generation Licensing

In this section:

- An introduction to generation licensing
- A guide to licence requirements for generators
- Information about how to apply for a licence
- A guide to the interactions you may need to have with NGESO
- Contact details if you need more information

Tip: Read the information boxes for definitions or explanations of terms that may be new or unfamiliar.

Introduction

Depending on the size of your generating project, you may need to apply for a Generation Licence. This section of the Guide explains how to determine whether your generating project requires a licence, and the process for obtaining a licence if you need one.

There are a number of issues regarding generation licensing which affect the relationships that you will have with other electricity sector organisations. In particular, if your generating unit(s) exports more than 100 MW, and therefore automatically requires a licence, you will need to talk with Elexon and NGESO about the implications of trading electricity in accordance with the Balancing and Settlement Code. This section of the Guide explains more about the relationship between developers of Distributed Generation and NGESO and highlights the different agreements that you could be required to enter into at the transmission level.

Full details are provided about the sources of further information that you will need to help you with the licence application process.

Who Requires a Generation Licence?

Currently all generation with an export capacity of greater than 100 MW requires a Generation Licence. Generation between 50 MW and 100 MW capacity may be given an exemption from the requirement to hold a licence, subject to applying to the Secretary of State for Business, Energy and Industrial Strategy for an exemption, and being granted one. You will not require a Generation Licence if your power station:

- does not export more than 10 MW;
- does not export more than 50 MW, provided your units have a combined declared net capacity of less than 100 MW (in simple terms declared net capacity is the maximum output of the generating units less the capacity consumed by the site, unless your energy source is either wind, solar, wave or tidal—see the information box below for further details); and
- was connected to the network before 30th September 2000, and does not export more than 100 MW, or has never been subject to central despatch.

You can check the details of whether your Generating project is exempt from the need for a Generation Licence and find a full definition of declared net capacity by looking at the UK government document [Statutory Instrument 2001 No. 3270, The Electricity \(Class Exemptions from the Requirement for a Licence\) Order 2001](#).

Requirements for a Generation Licence

The conditions which are included in a Generation Licence include a number of requirements affecting the interaction of your generating equipment with the transmission and distribution systems. So, for example, if you have a Generation Licence you will have to:

- comply with the sections of the Grid Code that apply to you;
- comply with the Distribution Code;
- comply with the Balancing and Settlement Code (BSC) and become a party to the Balancing and Settlement Code Framework Agreement;
- offer terms for providing Ancillary Services to the System Operator, if asked to do so;
- provide information to Ofgem as required;
- avoid discriminating between potential buyers of the electricity you generate; and
- advise the System Operator about the planned availability of your generating units in accordance with the requirements of the Grid Code.

Applying for a Generation Licence

To apply for a Generation Licence, you should look up the UK government document, [Statutory Instrument 2008 No. 2376, The Electricity \(Applications for Licences, Modifications of an Area and Extensions and Restrictions of Licences\) Regulations 2008](#). This contains detailed information about how to make the application, including information about the costs of a Generation Licence.

Your application should be sent to Ofgem and needs to include the following key items of information:

- the name, address and full contact details of the company making the application;
- the date from which the licence is required;
- company registration details, including names of directors.

This information should be provided in a form similar to that shown in the Statutory Instrument. In its current form the Generation Licence application doesn't require you to provide specific information about the generating equipment itself. These details will be needed, however, at the point when you apply to become a party to the Balancing and Settlement Code (BSC).

To summarise, it's important early on in the connection application process to work out whether you will need a Generation Licence or not. This depends on the **size** of, and level of export from, your generating units. The licence application process is clearly defined in the legislative documents referenced at the end of this section. If you need help filling in the application, you should consult a legal or technical adviser who is familiar with generation project development.

National Grid Interfaces

If your Distributed Generation project involves developing a large power station, you will need to enter into an agreement with NGENSO, the System Operator of the GB transmission system. This is because large power stations are likely to have an impact on the system at higher voltage levels than the distribution network. Power exports from large distributed generators could affect flows on the transmission system; in addition, large Distributed Generation can contribute to the balancing of the system as a whole. Because of this, if you're developing a large power station, you'll need to enter into a range of contracts with NGENSO and other parties.

The difference between the licence exemption limits described earlier and the technical definitions of large power stations gives rise to two different agreements which could apply to developers of Distributed Generation.

These are:

- the **Bilateral Embedded Generation Agreement (BEGA)** - an agreement between developers of power stations with a capacity of greater than 100MW and NGENSO. Generators are required under the terms of the BEGA to comply with the Connection and Use of System Code (CUSEC), the Grid Code and the Balancing & Settlement Code. The BEGA gives the generator the right to export onto the GB transmission system and to operate in the energy balancing market. Developers of small and medium power stations have the option to enter into a BEGA if they wish to take part in the wholesale electricity market;

- the **Bilateral Embedded Licence Exemptible Large Power Station Agreement (BELLA)** applies to large power stations which are exempt from having a generation licence. This agreement is only available to large power stations in Scotland, which could be below the 100 MW threshold at which holding a Generation Licence is mandatory. The BELLA Agreement sets out the provisions for generators to comply with the CUSC and Grid Code. They cannot operate in the electricity balancing market, however, and are not therefore required to comply with the Balancing and Settlement Code (BSC).

Medium power stations that are exempt from holding a Generation Licence are known as Embedded Medium Power Stations in EREC G99, and are also sometimes known as 'Licence Exemptible Embedded Medium Power Stations' (LEEMPS). Although they do not have explicit access to the transmission system, the DNO may need to agree an updated Bilateral Connection Agreement with National Grid which may impose conditions related to the generation. The DNO is likely to pass on any such obligations to the generator via the Connection Agreement.

If you have a BEGA with NGENSO, you are considered to be a user of the transmission system and are therefore liable to pay Transmission Network Use of System Charges.

If you do not have a BEGA you are not considered to be a user of the transmission system and you are not liable to pay Transmission Network Use of System Charges. However, you are not entitled to "use" the transmission system. In some circumstances this could limit the operation of a Distributed Generator not holding a BEGA.

You do not need to enter into an agreement with NGENSO if:

- you are developing a power station that has a capacity less than that of a large power station (see below, and note the variation for England & Wales and Scotland); and
- you do not require access to the transmission system.

However, certain elements of the Grid Code will still apply. The sections that apply are set out in the Distribution Code. The Guide to the Distribution Code contains figures that illustrate the Grid Code and Distribution Code boundaries.

In summary, the interface that you will have with NGENSO depends on where your generating project is located, its size and level of export. If you are developing a large power station, even if it is connected to the distribution network, you are considered to be a user of the transmission system and will need to discuss which agreements you will require and possible network charges with NGENSO. You may also be subject to charges for reinforcement work required on the transmission system to accommodate your project, depending on the outcome of studies undertaken by NGENSO.

Definition of a Large Power Stations

The definition of a large power station varies between England & Wales and Scotland, due to the different transmission voltage levels and system characteristics in these regions. The Grid Code defines large power stations as having a registered capacity as follows:

- 100 MW or above in the National Grid Transmission system
- 30 MW or above in the Scottish Power Transmission system
- 10 MW or above in the Scottish Hydroelectric Transmission system

More information about Transmission Charges

Full details of National Grid's Transmission Network Use of System Charges are available from: [NGESO](#)

Statement of Works Process

If you are not developing a large power station, ie you do not have an agreement with NGENSO (such as a BEGA or BELLA), then the DNO may submit a request to NGENSO for a Statement of Works. They will do this if they believe that your generating unit(s) may have an impact on the transmission network. If you are developing a large power station, then you will have discussions directly with NGENSO which will cover these issues.

The Statement of Works process allows NGENSO, and the relevant Transmission Owner, to determine if any work is required on the transmission system to allow your connection to go ahead. NGENSO will inform your DNO of the resulting decision and give any details they need. Your Connection Offer may include details of Transmission System Works if any are required along with securities and liabilities for transmission works. You may also be required to comply with technical conditions relating to the transmission system, either as specified in the Grid Code, or the DNO's site specific Bilateral Connection Agreement with NGENSO.

NGESO gives more information about Statements of Works on their website, including a guidance document for small embedded generation, available [here](#).

DNOs and NGENSO are currently looking to improve the Statement of Works process and are operating trials in a number of areas. If you want to know if your application may be covered by any of these trials, please contact your DNO. The revised process is discussed in more detail [Section 5: Cost and Charges - Connection Costs](#). In some cases, even much smaller generation can trigger this process. This may be because the transmission network may already be close to its statutory limits or to the ratings of the network equipment, and the addition of any generation, even if it is small, may be enough to exceed these limits.

The Statement of Works process can lead to significant additional costs if work is required, and may impose timescale constraints on your project, which need to be carefully considered. In some cases, the Statement of Works process can take more than 3 years. There is more information on the Statement of Works process in [Section 5: Costs and Charges: Connection Costs](#).

Where to Find More Information

The following UK Statutory Instruments are relevant:

- For full details on Generation Licence exemptions: [Statutory Instrument 2001 No. 3270, The Electricity \(Class Exemptions from the Requirement for a Licence\) Order 2001](#).
- To apply for a Generation Licence, you should look up the UK government document: [Statutory Instrument 2008 No. 2376, The Electricity \(Applications for Licences, Modifications of an Area and Extensions and Restrictions of Licences\) Regulations 2008](#)

We have referred to the following Codes in this section:

- The [Grid Code](#) and [Connection and Use of System Code \(CUSC\)](#) are available on National Grid's website
- The [Distribution Code](#) is available on the Distribution Code website
- The [Balancing and Settlement Code \(BSC\)](#) is available on Elexon's website

National Grid publishes information for new embedded (distributed) generation connections at: <https://www.nationalgrid.com/electricity-transmission/connections>

Getting Connected – Guidance on Compliance

PGMD iterations

The PGMD document contains a checklist of criteria which needs to be signed off by the DNO in as demonstrating compliance with the EREC G98 or G99 requirements. The PGMD is likely to be an iterative document between you and the DNO. Examples of the reasons for iterations and some issues to avoid include:

- DNOs are not able to open files you sent;
- Details on charts or schematic network diagrams are not legible (e.g. writing is too small);

- EREC G5 and EREC P28 assessments are not compliant with the latest versions of G5 and P28;
- Test results are not provided in accordance with EREC G98 or G99 requirements; and
- The equipment being modelled in the simulation studies is not the same as the one being installed.

Given the different nature of the requirements, and the fact that some requirements can be demonstrated early in your project and others towards the end, it is likely that you will submit different iterations of the PGMD documents at different times rather than a final PGMD at the end of the project. Once you send information to the DNO and they review it, they may ask for more details or clarification of the information submitted. To try to minimise the number of iterations of the PGMD between you and the DNO, some guidance is provided below as to what study results the DNO will expect to see included with your PGMD documents.

Compliance studies

You should submit data at the initial submission stage to demonstrate compliance with:

- Reactive power;
- Fault ride through; and
- Frequency response.

by providing a report of the power system analysis that has been undertaken for your power generating facility. EREC G99 Annex B.4 and Annex C.7 detail the studies required. The study report should enable the DNO to fully understand the system under study, the data used, the studies undertaken, the study results and how the results of the studies demonstrate compliance with EREC G98 or G99. As a minimum DNOs would expect the study report to contain:

- A single line diagram of the Power Generating Facility, including any equivalent networks that have been used (for example to represent the demand of a facility);
- Confirmation that the PGM(s), transformer and storage data used in the Power Generating Facility model is the same as the data you provided in the standard application form (SAF) at the application stage;
- A PGM or generating unit performance chart. This is a chart the manufacturer should provide showing the active power capability of the Power Generating Facility in both leading and lagging reactive power modes for different power factors. A typical chart is shown below in Figure 13; and
- Representation of the DNO network beyond the point of connection – this should be set up to represent the short circuit power MVA and X/R ratio of the DNO network (maximum or minimum as applicable for the study). The DNO can provide this information.

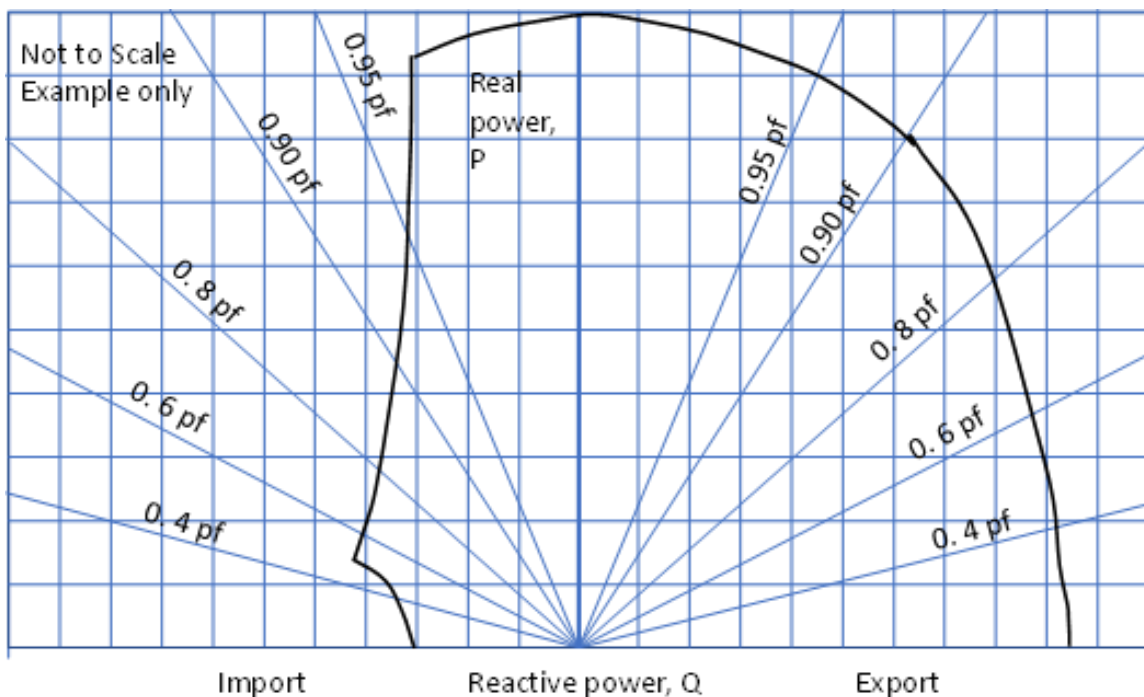

Figure 13: Typical chart provided by the manufacturer showing the active power capability of the Power Generating Facility

Reactive Capability across Voltage Range

The PGM must be capable of providing reactive power at the Connection Point in accordance with the requirements in EREC G99 for your PGM Type. A power system study of the Power Generating Facility should be undertaken to demonstrate reactive capability compliance. As a minimum the model should comprise the following items:

- The new PGM being connected (including the generating units that comprise the PGM);
- Any existing PGMs;
- The network between the PGM and the Connection Point;
- The network between generating units; and
- Representation of the remaining facility as necessary (for example demand or compensation equipment that would affect the power factor);

A load flow study should be undertaken to demonstrate that the power factor range at the Connection Point. The load flow should demonstrate that the Connection Point power factor is within the requirements of EREC G99:

- For Type B PGMs, this is at nominal voltage;
- For Type C and D PGMs, this is at nominal voltage plus 5% and nominal voltage minus 5%; and
- Studies should be undertaken at both the Registered Capacity of the PGM and the lowest power output that the PGM can stably operate at (minimum stable operating level).

In some cases, e.g. where a PGM is embedded within your installation and mainly meeting your demand, you and the DNO may agree that reactive power compliance is only necessary at the PGM terminals, rather than at the Connection Point. In this case:

- This may be recorded in your Connection Agreement; and
- A generator performance capability diagram should be sufficient to demonstrate reactive capability.

A simplified example of the required studies for Types C and D PGMs is given in the diagram below – refer to registered capacity example in the Appendix.

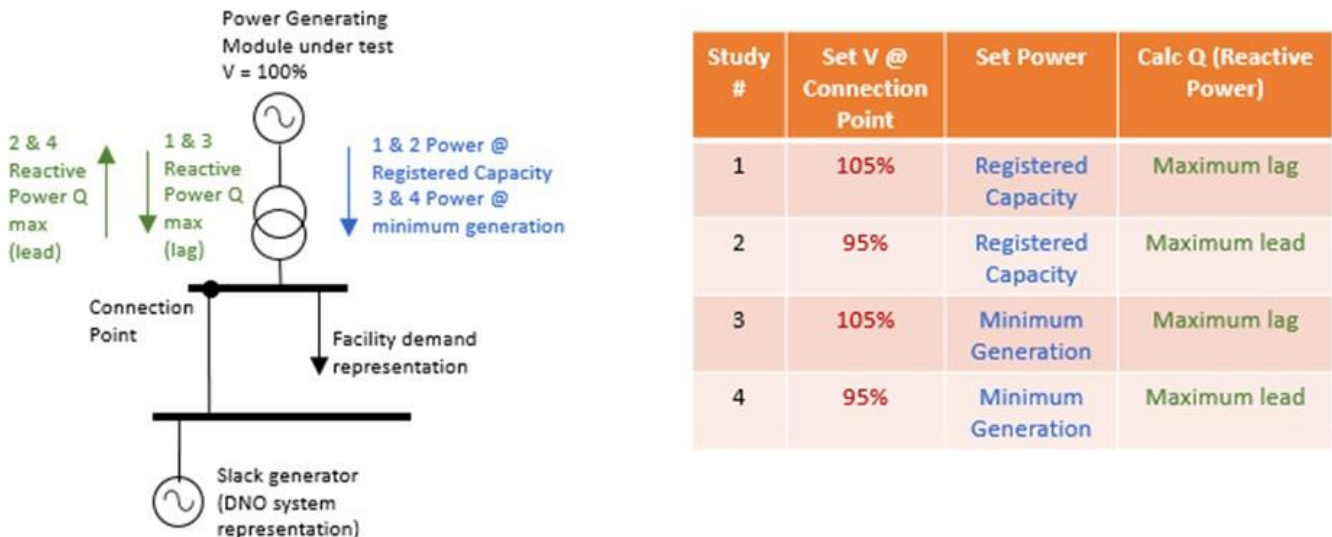

Figure 14: Example of Type C and D PGM studies.

Fault Ride Through and Fast Fault Current Capability

In order to demonstrate compliance with Fault Ride Through requirements in EREC G99, simulation studies should be carried out for the following conditions:

1. Three phase faults;
2. Phase to phase fault;
3. Two phase to earth fault; and
4. Single phase to earth fault.

In all cases, the simulations should demonstrate that:

- In the event of a fault on the distribution network the generating units will support the grid during the fault by increasing their reactive power injection to increase the grid voltage; and
- After the fault has been cleared by the system protection the voltage and active power will recover.

Time series simulation studies, where a fault is applied for 140 ms should be undertaken for the four conditions above. As an example, for a Type B PGM, the simulated fault should cause the voltage to fall by 70% for synchronous PGMs or by 90% for PPMs. This is different for Type C and D PGMs depending on voltage at the Connection Point and whether you are connecting a synchronous PGM or a PPM. The study should demonstrate that the recovery of the voltage at the Connection Point should be within the acceptable envelope as detailed in EREC G99. A simplified example of the required studies for a Type B PGM is given in Figure 15.

Fast fault current injection studies are also required for PPMs. This is where a PPM supports the system for up to 140 ms if there is a fault on the transmission system by injecting reactive current. The study should demonstrate that the injection of reactive power at the Connection Point should be within the acceptable range as detailed in EREC G99.

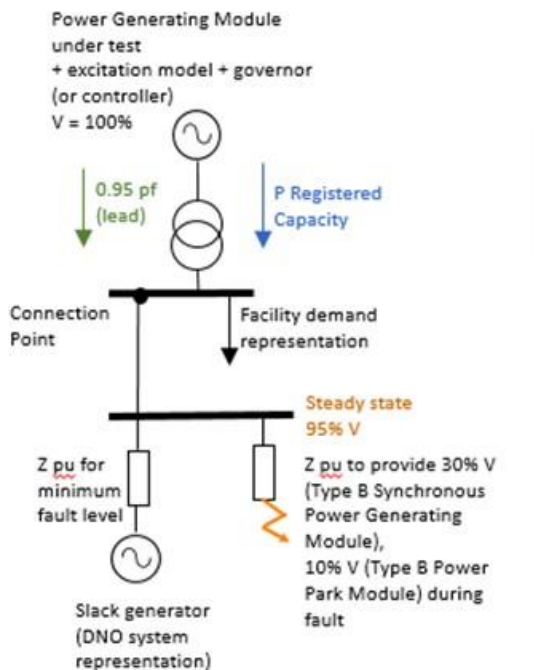

Study #	Set Voltage @ Connection Point	Set Power	Set pf	Fault type	Fault time
1	95%	Registered Capacity	0.95	Three phase	140 ms
2	95%	Registered Capacity	0.95	Phase to phase	140 ms
3	95%	Registered Capacity	0.95	Single phase to earth	140 ms
4	95%	Registered Capacity	0.95	Two phase to earth	140 ms

Figure 15: Example of Type B PGM studies.

Frequency studies

In order to demonstrate compliance with the frequency response requirements, simulation studies should be carried out to demonstrate the over and under frequency response (as applicable to your PGM). The studies can be undertaken by modelling the injection of a frequency signal (ramp or step) into the governor or controller model. For Limited Frequency Sensitive Mode – Over frequency (LFSM-O) when the frequency increases the PGM should respond by reducing active power. The response, which will depend on the droop setting, should start when the frequency reaches 50.4 Hz unless you have been contracted by the System Operator to operate in frequency sensitive mode. This requirement is applicable to Type B, Type C and Type D PGMs. For Limited Frequency Sensitive Mode – Under frequency (LFSM-U) when the frequency decreases the PGM should respond by increasing active power. This requirement is applicable to Type C and Type D PGMs. The initial operating condition should be that the PGM is generating at 80% of its capacity. The response, which will depend on the droop setting, should start when the frequency reaches 49.5 Hz unless you have been contracted by the System Operator to operate in frequency sensitive mode. The studies you submit as part of the PGMD should demonstrate this response according to the PGM droop setting and in line with the EREC G99 frequency requirements.

Validation studies

The generator, governor or frequency controller models and the excitation model should be validated against physical test results. It is expected that this would be undertaken by the PGM manufacturer, but this could be done after site tests, if required.

Providing simulation models

If your PGM is Type C or D, you will need to provide the DNO with the validated simulation models used in your studies. The DNO will normally ask for this in a format that is compatible with the power system analysis software that they use – check this with your DNO. Some manufacturers provide “blackbox” models. This is

where the model gives the correct outputs, but the internal workings of the model are not transparent to the user. Manufacturers do this to protect their intellectual property. You can provide these to the DNO or the manufacturer might provide this directly to the DNO, but be aware that the DNO will want assurance from the manufacturer that the model correctly represents the equipment in power system studies and what you are proposing to install. The DNO might ask for guidance on “black box” models, or study cases and scenarios.

Section 5: Costs and Charges

This section introduces the rules around connection costs and ongoing costs to facilitate and manage new connections onto the distribution network.

Section 5.1: G98 Single Premises & G98 Multiple Premises, Costs and Charges

Use of System Charges

Use of System charges are levied by the DNO to the supplier, so as a generator you will not be charged these directly. However, this section is included for your information, as Use of System charges may appear as an item on your bill.

What are Use of System charges?

Use of System charges cover the development, operation, maintenance, and repair of the distribution network. DNOs make Use of System charges to suppliers. Suppliers may reflect these charges to their customers as either:

- a 'pass-through' item so that the customer can clearly see the Use of System element; or
- 'wrapped-up' in a total electricity supply tariff where the customer may not be able to clearly see the Use of System element.

DNOs are obliged to publish documents about their Use of System charges. These cover their Use of System charging methodology and a statement of what the charges are for both generation and demand customers. You can find these on DNOs' websites.

All generators connected at Low Voltage are subject to Generation Distribution Use of System charges under the Common Distribution Charging Methodology (CDCM). These charges may be negative (ie credits). You can find out more about the Common Distribution Charging Methodology (CDCM) by looking at [Distribution Charging](#) on the Ofgem website, [Distribution Charges Overview](#) on the Energy Networks Association website and some DNOs' websites.

Categories of Use of System charges

UoS charges are categorised by:

- the voltage level your equipment is connected to and;
- the type of meter you have.

The boxes below define the voltage level that will apply to EREC G98 compliant equipment (Low Voltage) and the metering arrangements that are likely to apply to this equipment (Non-Half Hourly meters). With the Common Distribution Charging Methodology charges for LV generation customers with NHH meters are in the form of unit rates (p/kWh).

Distribution Use of System charges are subject to review by Ofgem and significant changes are underway. Refer to [Ofgem's website](#) for more information.

LV (Low Voltage)	400/230 V in practice, less than 1 kV in general.
-------------------------	---

Non-Half Hourly Meters (NHH)

NHH meters record total energy passing through the meter, but do not record the times the energy is transferred. Typically, the recorded data would be collected a few times a year, eg. every quarter. Most domestic and small commercial properties have NHH meters. You can contact your current electricity supplier to discuss the provision of NHH meters, or other meter suppliers.

Domestic properties are being encouraged to have a smart meter installed. Smart meters record total energy passing through the meter every HH. The introduction of smart meters should improve consumer awareness of energy consumption and will allow for the introduction of time of use tariffs.

Section 5.2: G98 Multiple Premises & G99 Type A, Costs and Charges

In this section:

- An introduction to connection costs
- The basis of DNO connection charges for infrastructure
- Other elements of connection charges and where to find indicative costs and examples
- Generation Distribution Use of System charges

Read the boxes for definitions or explanations of terms that may be new or unfamiliar.

Introduction

There are two categories of charges made by the DNO:

- **Connection charge:** this is a one-off charge made by the DNO, which primarily covers the cost of work and equipment associated with connecting your generating project to the distribution network. This includes a portion of reinforcement costs.
- **Use of System charges:** these are ongoing charges, which primarily cover operation and maintenance costs and include the costs of ongoing network development including general reinforcement.

DNOs are obliged to publish documents describing the basis of their connection charges and their charging methodology. They also present the different elements of connection charges, and indicative costs for works and equipment of significant cost. This will help you to understand the charges they quote you.

This information is contained in the DNOs' Statement of Methodology and Charges for Connection to the electricity distribution system. All DNOs' statements follow the same format and are available on their websites. This document contains:

- The DNO's connection charging methodology (i.e., how they calculate their charges);
- The DNO's connection charging statement (i.e., what the charges are);
- An indication of the costs of providing a connection quotation / budget estimate; and
- Other relevant information for connecting customers.

The basis and elements of connection charges, as well as indicative costs and examples are discussed in this section.

Use of System charges are levied by the DNO on the supplier, so as a generator you will not be charged these directly. However, this section is included for your information, as Use of System charges may appear as an item on your bill.

Connection Charges

Depending on the location and size of your generating units, new equipment and reinforcement to the existing network may be necessary to accommodate your generation. In the connection charge, you will be charged for any extension to the network.

DNOs are obliged to publish a document describing the basis of their connection charges and their charging methodology. You can refer to this document to see what costs you will be charged for. These are available on DNO websites.

Connection Charges – Other Elements

Elements of charges

As well as charges for any network extension (if required), there are other elements that are covered in the connection charge. These can include the following:

- System / feasibility / fault level studies
- Provision of Wayleaves
- Additional meetings with the DNO or site visits
- Administration

Note that not all DNOs apply charges for all of these items, and that not all of these items will be relevant for your project.

Indicative costs and examples

Equipment costs and charges for services vary across DNOs; it could therefore be misleading to list indicative costs in this Guide. If you want to get an idea for indicative costs, the best place to look is the **DNO's Statement of methodology and charges for connection**. You can find this on the DNO's website.

Aside from giving indicative costs for connection charges, these documents typically contain other useful information, including guidance on the connection process and examples of various connections and their associated cost breakdown. It is updated annually.

The connection charging methodology is governed by the Distribution Connection and Use of System Agreement (DCUSA) and is subject to open governance so any party materially affected by it can propose a change to it. The process for doing this is laid out within the DCUSA itself. See the DCUSA website for more information: <https://www.dcusa.co.uk/dcusa-document/>

The Distribution Charging Methodologies Forum exists to enable parties to discuss ideas for improving the methodology possibly prior to submitting a formal change proposal.

Estimating costs and getting a quotation

As mentioned, you can obtain indicative costs for works and equipment from DNO documents. To obtain a more accurate picture of the connection costs for your project, you can:

- Ask the DNO for a budget estimate
- Obtain an estimate of connection costs from a specialist engineering consultant

You should exercise care in interpreting budget estimates. DNOs use reasonable endeavours to identify remote reinforcement costs associated with the proposed connection at this stage. However, it is possible that not all of the reinforcement costs will be included at this time.

Payment of connection charges

Connection charges are paid either:

- in full at the time that the connection offer is accepted; or
- in staged or phased payments, as per a payment schedule.

Staged payments are typically used for generation projects which are greater than a certain size, eg. in project value or duration. The staged payments cover committed expenditure by the DNO.

If your connection does not proceed, it is possible that some of the connection charge will be refundable depending on if the DNO has performed the work. You should inform your DNO as soon as possible if you decide not to go ahead with your project.

Charging Futures Forum: The Charging Futures Forum is a programme that co-ordinates significant reform of electricity network access and electricity network charging arrangements. Ofgem is the chair of the programme, and members include generators, network operators, large customers, industry bodies and universities. The

programme includes holding a quarterly forum and teams called Task Forces, which review specific issues in detail. For more information see the [Charging Futures Forum](#) website.

What is a budget estimate?

You may read about **budget** or **indicative estimates** and **formal quotations**. The differences between these two terms are summarised in the following table.

Table 9: Difference between Budget or Indicative estimates and Formal quotations.

Budget or Indicative estimate	Formal quotation
Requested in the early stage of a project, and generally, only for larger capital schemes	Requested when electrical requirements have been finalised
The DNO doesn't require much information from you	The DNO requires a lot of information from you
Based on a desktop study—the DNO is unlikely to carry out detailed designs or studies	Based on detailed design work, and may require other input such as site surveys
To give an indication of costs, and is therefore subject to change	Provides formal contract offer
Not open for acceptance	Open to acceptance, subject to conditions
DNO may charge	DNO will not charge

Assuming that you ask the DNO to undertake all of the work involved in your connection, the timescale for the DNO to provide a budget estimate is 10 working days.

Connection Offer expenses (Assessment and Design fees)

Following a government consultation, DESNZ is now allowing DNOs to charge Connection Offer expenses (also known as Assessment and Design fees), regardless of whether or not the subsequent Connection Offer is accepted. Connection Offer expenses are a charge by the DNO for the cost of producing Connection Offers, and cover activities such as network modelling, connection design and site surveys. These changes came into force in April 2018. For further information refer to the [DESNZ website](#).

Note that DNOs are applying these charges differently. For example, some are only applying them to projects with certain connection voltages. Refer to your DNO website for details on how they are applying the charges

Section 5.3: G99 Type A, Costs and Charges

Use of System Charges

Use of System (UoS) charges cover operation, repair and maintenance of network assets, and also any reinforcement to the network that might be necessary that is not covered by the connection charge.

All generators with equipment connected at LV and HV are subject to UoS charges under the Common Distribution Charging Methodology (CDCM). Generators with equipment connected at EHV are subject to UoS charges under the EHV Distribution Charging Methodology (EDCM).

These charges can be negative for generation (i.e., credits). Please see the table below for definitions of the terms LV, HV and EHV.

DNOs are obliged to publish documents about their UoS charges. These cover their UoS charging methodology and a statement of what the charges are for both generation and demand customers. You can find these on DNOs' websites.

You can find out more about the Common Distribution Charging Methodology (CDCM) and EHV Distribution Charging Methodology (EDCM) from DNOs' websites and [Charging Arrangements](#) section on Ofgem website.

Distribution Use of System charges have been and are subject to two of Ofgem's Significant Code Reviews – the Targeted Charging Review (TCR) and the Access and forward-looking charges review. For more information see page 136 and 137.

Definitions of LV, HV and EHV:

Term	Voltage level
LV (Low Voltage)	In general: less than 1 kV. In practice, this means 400/230 V
HV (High Voltage)	In general: 1 kV—22 kV. In practice, this means 6.6, 11 or 20 kV.
EHV (Extra High Voltage)	In general, this covers connection to the distribution network at or above 22 kV. In practice this means 33 or 66 kV, (or 132 kV in England and Wales only). Some DNOs may define this slightly differently. See the definition of EHV for your local DNO.

Metering Requirements, Parties and Charges

Metering requirements

You may require separate meters for measuring your import and export. There are two categories of meter:

- Half Hourly (HH)
- Non-Half Hourly (NHH)

They are described in the box below.

The type of meter will affect:

- the meter charges you pay; and
- what category of UoS charges apply.

Section L of the Balancing and Settlement Code (BSC) dictates the type of meter you will require. If you are classed as a 'Small Scale Third Party Generating Plant' (currently defined as less than 30kW capacity), you can choose to have a NHH meter. Otherwise, you have to have a HH meter, if metering export. HH meters can provide metering data for each half hour period, and so can be useful for understanding your electricity import or export at different times of the day. However, they have significant costs associated with them.

Parties involved

NHH meters are the responsibility of the supplier. They will appoint the following Supplier Agents:

- Meter Operator: installs and maintains the meter
- Data Collector: retrieves the data recorded by the meter and calculates your actual or estimated volume of energy consumption
- Data Aggregator: sums up volumes of energy consumed for each supplier and sends the information to a central system for balancing and settlement

You can choose to contact your supplier about the provision of meters, or contract directly with a Meter Operator. If you use HH metering, it is your responsibility to appoint a Meter Operator. You will have to enter into a Meter Operator contract with a meter supplier. The contracts normally last for five years, and the Meter Operator will:

- Provide, install and maintain your meter; and
- Collect data from your meter via a communications link such as a telephone line, the provision of meters is open to competition. Details of Meter Operators and their contact details can be found on the Association of Meter Operators website: <https://meteroperators.org.uk/>

There are Codes of Practice which detail technical requirements for Metering Systems. These can be found on [Elexon's website](#).

Charges

The cost of Meter Operator agreements and the costs associated with the communication to collect data from your meter can be in the order of several hundred pounds a year. You should consider obtaining quotations from a number of Meter Operators.

Note: in practice suppliers may pay the owner of some smaller Distributed Generation a fixed amount (e.g. £/year) instead of installing meters and making payments based on units exported. This is something you can discuss with your supplier.

Half Hourly (HH) meters and Non-Half Hourly (NHH) meters

Meters record the flow of electricity. There are two main categories of meters; Half Hourly (HH) and Non-Half Hourly (NHH). HH meters are for larger customers; if your generation peak power is greater than 30 kW you have to use a HH meter, if metering export.

NHH meters record total energy passing through the meter, but do not record the times the energy is transferred. Typically, the recorded data would be collected a few times a year, eg. every quarter. In contrast, HH meters measure and record energy passing through the meter for each half hour period. The data they record is typically collected remotely every day, for example by a telephone line.

Domestic properties are being encouraged to have a smart meter installed. Smart meters record total energy passing through the meter every HH. The introduction of smart meters should improve consumer awareness of energy consumption and will allow for the introduction of time of use tariffs.

Data from meters is used to determine charges and rewards. For example, to calculate:

- Imbalance charges for balancing and settlement
- Distribution or Transmission UoS charges

- Renewables Obligations Certificate rewards

Section 5.4: G99 Type B-D, Costs and Charges

In this section:

- An introduction to connection costs
- The basis of DNO connection charges for infrastructure
- Other elements of connection charges and where to find indicative costs and examples
- National Grid Electricity System Operator (NGESO) connection charges and Statement of Works

Tip: Read the information boxes for definitions or explanations of terms that may be new or unfamiliar.

Introduction

There are two categories of charges made by the DNO:

- **Connection charge:** this is a one-off charge made by the DNO, which primarily covers the cost of work and equipment associated with connecting your generating project to the distribution network. This includes a portion of reinforcement costs.
- **Use of System charges:** these are ongoing charges, which primarily cover operation and maintenance costs and include an element to cover the costs of ongoing network development including general reinforcement.

This section focuses on connection costs. Information on Use of System and other charges can be found in the [Section 5: Costs and Charges: Ongoing Costs](#).

DNOs are obliged to publish documents describing the basis of their connection charges and their charging methodology. They also present the different elements of connection charges, and indicative costs for works and equipment of significant cost. This will help you to understand the charges they quote you.

This information is contained in the DNOs Statement of Methodology and Charges for Connection to the electricity distribution system. All DNOs' statements follow the same format and are available on their websites. This document contains:

- The DNO's connection charging methodology (i.e., how they calculate their charges);
- The DNO's connection charging statement (i.e., what the charges are);
- An indication of the costs of providing a connection quotation / budget estimate; and
- Other relevant information for connecting customers.

The basis and elements of connection charges, as well as indicative costs and examples are discussed in this section.

Connection Charges – Other Elements

Elements of charges

As well as charges for any network extension (if required), there are other elements that are covered in the connection charge. These can include the following:

- System / feasibility / fault level studies
- Where work has been undertaken by an ICP: Design approval, Inspection, and monitoring of work, Witnessing tests
- Determining or providing information on point of connection
- Additional meetings with the DNO or site visits
- Administration, Provision of Wayleaves, NGESO fees eg. application for Statement of Works
- Substation locks and notices

Note that not all DNOs apply charges for all of these items, and that not all of these items will be relevant for your project.

Indicative costs and examples

Equipment costs and charges for services vary across DNOs; it could therefore be misleading to list indicative costs in this Guide. If you want to get an idea for indicative costs, the best place to look is the **DNO's Statement of methodology and charges for connection**. You can find this on the DNO's website.

Aside from giving indicative costs for connection charges, these documents typically contain other useful information, including guidance on the connection process and the breakdown of Contestable and Non-contestable work. The Statement of methodology and charges for connection document also gives examples of various connections and their associated cost breakdown. It is updated annually.

The connection charging methodology is governed by the Distribution Connection and Use of System Agreement (DCUSA) and is subject to open governance so any party materially affected by it can propose a change to it. The process for doing this is laid out within the DCUSA itself. See the DCUSA website for more information: <https://www.dcusa.co.uk/dcusa-document/>

The Distribution Charging Methodologies Forum exists to enable parties to discuss ideas for improving the methodology possibly prior to submitting a formal change proposal.

Connection Offer expenses (Assessment and Design fees)

Following a government consultation, DESNZ is now allowing DNOs to charge Connection Offer expenses (also known as Assessment and Design fees), regardless of whether or not the subsequent Connection Offer is accepted. Connection Offer expenses are a charge by the DNO for the cost of producing Connection Offers, and cover activities such as network modelling, connection design and site surveys. These changes came into force in April 2018. For further information refer to the [DESNZ website](#).

Note that DNOs are applying these charges differently. For example, some are only applying them to projects with certain connection voltages. Refer to your DNO website for details on how they are applying the charges.

Estimating costs and getting a quotation

To obtain a more accurate picture of the connection costs for your project, you can:

- Ask the DNO for a budget estimate
- Obtain an estimate of connection costs from a specialist engineering consultant

You should exercise care in interpreting budget estimates:

- Normally they only cover the cost of the infrastructure on the DNO's side of the point of supply. There can be significant costs associated with the infrastructure on your side of the point of supply.
- DNOs use reasonable endeavours to identify remote reinforcement costs associated with the proposed connection at this stage. However, it is possible that not all of the reinforcement costs will be included at this time.

For more on budget estimates, see the information box below. You should consider the costs on both sides of the point of supply when evaluating your connection options. For example, the DNO might indicate that the connection costs would be lower if they were to provide a supply at 33 kV instead of 11 kV. But this option might require you to install and operate a 33 kV/11 kV transformer, in which case you would have to weigh the cost of the transformer against the lower DNO costs.

Payment of connection charges

Connection charges are paid either:

- in full at the time that the connection offer is accepted; or
- in staged or phased payments, as per a payment schedule.

Staged payments are typically used for generation projects which are greater than a certain size, eg. in project value or duration. The staged payments cover committed expenditure by the DNO.

If your connection does not proceed, it is possible that some of the connection charge will be refundable depending on if the DNO has performed the work. You should inform your DNO as soon as possible if you decide not to go ahead with your project.

Charging Futures Forum: The Charging Futures Forum is a programme that co-ordinates significant reform of electricity network access and electricity network charging arrangements. Ofgem is the chair of the programme, and members include generators, network operators, large customers, industry bodies and universities. The programme includes holding a quarterly forum and teams called Task Forces, which review specific issues in detail. For more information see the [Charging Futures Forum](#) website.

What is a budget estimate?

You may read about **budget or indicative estimates** and **formal quotations**. The differences between these two terms are summarised in the following table.

Table 10: Difference between Budget or Indicative and Formal quotation.

Budget or Indicative estimate	Formal quotation
Requested in the early stage of a project, and generally, only for larger capital schemes	Requested when electrical requirements have been finalised
The DNO doesn't require much information from you	The DNO requires a lot of information from you
Based on a desktop study—the DNO is unlikely to carry out detailed designs or studies	Based on detailed design work, and may require other input such as site surveys

To give an indication of costs, and is therefore subject to change	Provides formal contract offer
Not open for acceptance	Open to acceptance, subject to conditions
DNO may charge	DNO will not charge

The Distributed Generation performance standard, introduced by the Distributed Generation standards directive, defines time periods within which DNOs should respond to a request for a budget estimate. This applies to Section 16 Applications (i.e. if you are applying to the DNO to undertake both the Contestable and Non-contestable elements of the connection work). The timescales for the DNO to provide a budget estimate are:

- 10 working days for connections of less than 1 MVA; and
- 20 working days for connections of 1 MVA or more.

Timelines for formal quotations are given in the information boxes in [Section 3.5: Design Phase](#).

Transmission Connection Charges

In some cases, Distributed Generation may have an effect on the transmission network. NGENSO may need to carry out studies to assess whether the impact of your project on the transmission network is significant. This is more likely if the project is larger, as explained below:

- **A small power station:** If the DNO “reasonably believes” the installation may have a significant impact on the transmission system, they may submit a request to NGENSO for a Statement of Works. Due to increasing levels of Distributed Generation, an increasing number of small power station projects are considered to have an impact on the transmission system and need to follow the Statement of Works process.
- **A medium power station exempt from holding a generation licence:** If there is to be no direct agreement with NGENSO, then the DNO will request NGENSO for a Statement of Works (see [Section 4: The Connection Application: Generation Licensing](#) for more on bilateral agreements).
- **A large power station, or medium power station with a generation licence:** You will need to enter into various agreements with NGENSO. You will need to notify NGENSO of your project and have discussions with them. This will include the need for studies and the possibility of reinforcement charges.

Fault Level

Fault level is a measure of the current which would occur in the event of a solid 3-phase short circuit at a certain point on an electricity network. Fault level is normally expressed in thousands of Amps (kA) or the equivalent apparent power (MVA). It is normally given as a range of values, as it can change over time. This can be due to changes in the network configuration to allow routine maintenance or isolate faults. The rating of existing circuit breakers and circuits place an upper limit on the range of fault levels that can be permitted in a particular part of the network. Your generating equipment can contribute to fault current, so it increases the fault level on the network. If connecting your generating equipment increases the fault level above the capability of the DNO equipment, you may have to contribute to reinforcements.

Statement of Works

The Statement of Works process indicates what, if any, work needs to be carried out on the transmission system as a result of initial assessments.

If a Statement of Works is requested by the DNO, the relevant Transmission Owner will undertake initial studies to assess the impact of your generation on the transmission system. If your project does not have a significant impact, the process is complete.

You will be required to pay the application fee for the request for Statement of Works. This fee depends on your geographical location, and can be found in [National Grid's Statement of Use of System Charges](#).

If your project does have a significant impact, the relevant Transmission Owner may need to:

- Undertake works on the transmission system or on a grid supply point; and
- Set specific requirements at your connection site.

The Statement of Works process indicates whether there is a need to carry out additional reinforcement works on the transmission network as a result of the new Distributed Generation project (which includes storage connections). As a result of the Statement of Works, NGENSO may impose conditions on the DNO regarding the Distributed Generation connection. These conditions are captured in the Construction Agreement between you and the DNO, and any bilateral agreement you may have with NGENSO. Throughout this process, you will not have any direct contact with National Grid, unless you are applying for a BEGA, and this process will be handled by your DNO. Timescales for this process are prescribed in the CUSC. These need careful consideration as they may impose timescale constraints on your project. For more information, please refer to the [National Grid website](#) and [Section 6.5 of the CUSC](#). National Grid gives more information about this process in the '[Small Embedded Generation](#)' section of their website.

Transmission Impact Assessment (TIA)

In recent years, the volume of applications for connection of both generation and storage has been putting strain on the Statement of Works process and causing delays to customers. DNOs have been and are continuing to work with NGENSO to review and revise the process, in order to reduce response times and costs, where possible.

In the new process National Grid as NETSO (National Electricity Transmission System Operator), in conjunction with Transmission Owners, will develop planning limits or materiality headroom for Grid Supply Points (GSP) that will be available to DNOs. These limits indicate the available capacity at transmission level that can be offered for connection without the need for further assessment. This assessment may also indicate any associated transmission works that will be required to connect DG, along with timescales and costs. For the DG customer, this means the DNO can make a connection offer without an individual application to the NETSO in many cases. This gives applicants more and better information earlier in the process, and greater certainty. Your offer will also detail any associated security and liability you will be required to put in place with the DNO for the associated transmission works.

This process has been trialled at a number of GSPs, by a number of DNOs, and has been referred to as an "Appendix G process". For connections to GSPs that have not been part of the trial, the existing Statement of Works process still applies. Through the Open Networks project and a National Grid CUSC Working group, work is continuing to further improve the new process, which will be referred to as Transmission Impact Assessment (TIA).

Financial liabilities associated with Transmission Works

The DNO may be required to secure financial sums payable to NGENSO for transmission works that would not be required if your generation project does not proceed ("final sums liabilities"). The DNO would pass these liabilities on to you as the project developer. Under NGENSO's new scheme for connecting generation, the Connect and Manage scheme, the way in which these liabilities are shared between network users changes slightly. You should discuss this issue with your DNO.

Where to Find More Information

You can find out more information about your DNO's connection charges from their websites:

DNO	Link to Connection Charge Documents
Electricity North West	https://www.enwl.co.uk/about-us/regulatory-information/use-of-system-charges
Northern Powergrid	https://www.northernpowergrid.com/use-of-system-charges
SP Energy Networks	https://www.spenergynetworks.co.uk/pages/regulation_guidance_leaflets.aspx https://www.spenergynetworks.co.uk/userfiles/file/SPEN_connection_methodology.pdf
SSE	Connections - useful documents - SSEN Charging statements and information - SSEN
UK Power Networks	Distribution Network Operator UK Power Networks
National Grid	National Grid Costs and Charging

Ongoing Charges

In this section:

- An introduction to ongoing charges
- Generation Distribution Use of System charges—how they vary and what they cover
- Metering charges and the parties involved
- Top-up and stand-by charges
- Charges for using the transmission system

Tip: Read the information boxes for definitions or explanations of terms that may be new or unfamiliar.

Introduction

There are two categories of charges made by the DNO:

- **Connection charge:** this is a one-off charge made by the DNO, which primarily covers the costs of work and equipment associated with connecting your generating project to the distribution network. This includes a portion of reinforcement costs.
- **Use of System charges:** these are ongoing charges, which primarily cover operation and maintenance costs and include an element to cover the costs of ongoing network development including general reinforcement.

This section discusses Use of System charges, as well as other ongoing charges that may apply to you. Ongoing charges are associated with some of the running costs of your generating equipment.

Depending on the nature of your project these can include:

- Generation Distribution Use of System (UoS) charges
- Metering charges
- Top-up and standby charges
- Charges for the use of the transmission system

We will discuss these charges in more detail.

Use of System charges are levied by the DNO to the supplier, so as a generator you will not be charged these directly. However, this section is included for your information, as Use of System charges may appear as an item on your bill.

Generation Distribution Use of System Charges

Use of System (UoS) charges are ongoing charges, which primarily cover operation and maintenance costs and include an element to cover the costs of ongoing network development including general reinforcement.

All generators with equipment connected at LV and HV are subject to UoS charges under the Common Distribution Charging Methodology (CDCM). Generators with equipment connected at EHV are subject to UoS charges under the EHV Distribution Charging Methodology (EDCM).

These charges can be negative for generation (i.e. credits). Please see the table below for definitions of the terms LV, HV and EHV.

There are special arrangements in place for Generators whose equipment was connected at EHV before April 2005. Refer to Ofgem decision documents about exemptions for pre-2005 generators for more information.

DNOs are obliged to publish documents about their UoS charges. These cover their UoS charging methodology and a statement of what the charges are for both generation and demand customers. You can find these on DNOs' websites. You can find out more about the CDCM and the EDCM from DNOs' websites and [Charging Arrangements](#) section on Ofgem's website. The EDCM and CDCM charging methodology are governed by the DCUSA and are subject to open governance.

Distribution Use of System charges have been and are subject to two of Ofgem's Significant Code Reviews – the Targeted Charging Review (TCR) and the Access and forward-looking charges review. For more information see page 136 and 137.

Metering Requirements, Parties and Charges

METERING REQUIREMENTS

You may require separate meters for measuring your import and export. There are two categories of meter:

- Half Hourly (HH)
- Non-Half Hourly (NHH)

They are described in the box below.

The type of meter will affect:

- the meter charges you pay; and
- what category of UoS charges apply.

Section L of the Balancing and Settlement Code (BSC) dictates the type of meter you will require. If you are classed as a 'Small Scale Third Party Generating Plant' (currently defined as less than 30kW capacity), you can choose to have a NHH meter. Otherwise, you have to have a HH meter, if metering export. HH meters can provide metering data for each half hour period, and so can be useful for understanding your electricity import or export at different times of the day. However, they have significant costs associated with them.

PARTIES INVOLVED

NHH meters are the responsibility of the supplier. They will appoint the following Supplier Agents:

- Meter Operator: installs and maintains the meter

- Data Collector: retrieves the data recorded by the meter and calculates your actual or estimated volume of energy consumption
- Data Aggregator: sums up volumes of energy consumed for each supplier and sends the information to a central system for balancing and settlement

If you use HH metering, it is your responsibility to appoint a Meter Operator. You will have to enter into a Meter Operator contract with a meter supplier. The contracts normally last for five years, and the Meter Operator will:

- Install and maintain your meter; and
- Collect data from your meter via a communications link such as a telephone line

The provision of meters is open to competition. Details of Meter Operators and their contact details can be found on the Association of Meter Operators website: www.meteroperators.org.uk

There are Codes of Practice which detail technical requirements for Metering Systems. These can be found on [Elexon's website](#).

CHARGES

The cost of Meter Operator agreements and the costs associated with the communication to collect data from your meter can be in the order of several hundred pounds a year. You should consider obtaining quotations from a number of Meter Operators.

Note: in practice suppliers may pay the owner of some smaller Distributed Generation a fixed amount (eg. £/year) instead of installing meters and making payments based on units exported. This is something you can discuss with your supplier.

Half Hourly (HH) meters and Non-Half Hourly (NHH) meters

Meters record the flow of electricity. There are two main categories of meters; Half Hourly (HH) and Non-Half Hourly (NHH). HH meters are for larger customers; if your generation peak power is greater than 30 kW you have to use a HH meter, if metering export.

NHH meters record total energy passing through the meter, but do not record the times the energy is transferred. Typically, the recorded data would be collected a few times a year, e.g. every quarter. In contrast, HH meters measure and record energy passing through the meter for each half hour period. The data they record is typically collected remotely every day, for example by a telephone line.

Domestic properties are being encouraged to have a smart meter installed. Smart meters record total energy passing through the meter every HH. The introduction of smart meters should improve consumer awareness of energy consumption and will allow for the introduction of time of use tariffs.

Data from meters is used to determine charges and rewards. For example, to calculate:

- Imbalance charges for balancing and settlement
- Distribution or Transmission UoS charges
- Renewables Obligations Certificate rewards

Top-up and Standby Charges

You may require top-up and standby electricity supplies to supplement the output from your generating units:

- **Top-up supplies** cover any routine shortfall between the output of your generating units and the demand on your site, and are generally used frequently (electricity supply on a regular basis).
- **Standby supplies** cover your demand in exceptional circumstances, such as generation outages (electricity supply on an intermittent basis). Even if you have no on-site demand or customers, standby supplies are usually required to cover the load associated with auxiliary equipment during start-up.

Top-up and standby supplies can be purchased from any electricity supplier, other Distributed Generation, or directly through market mechanisms such as a power exchange or the Balancing Mechanism.

Charges Applied by NGENSO

TRANSMISSION NETWORK USE OF SYSTEM CHARGES

Similar to the UoS charges applied by DNOs to generators or demand customers who use their distribution system, National Grid makes Transmission Network Use of System (TNUoS) charges. National Grid publishes a Statement of the Use of System Charging Methodology on their website. According to this statement, you will be eligible for TNUoS charges if you are required to hold a generation license and you have a Bilateral Embedded Generator Agreement (BEGA). Please see [Section 4: The Connection Application: Generation Licensing](#) for more information on agreements with NGENSO.

The TNUoS charges vary by geographic region. To see what the charges are in your area, refer to the Statement of Use of System Charges on the National Grid website. Note that charges can be positive and negative, and that small generators connected at 132 kV in Scotland are eligible for a reduction in TNUoS charges.

Transmission Use of System charges have been and are subject to two of Ofgem's Significant Code Reviews – the Targeted Charging Review (TCR) and the Access and forward-looking charges review. Significant changes are underway. Refer to the section on Changes to Use of System Charges on page 136 for more information.

BALANCING SERVICES USE OF SYSTEM CHARGES

NGESO is allowed to make charges for balancing service activities; for the role they play in operating the transmission system and balancing the system in real-time. These charges are called Balancing Services Use of System (BSUoS) charges.

The Use of System Charging Methodology states that all CUSC (Connection and Use of System Code) parties are liable for BSUoS charges. Please refer to the CUSC document for more information. There are a number of developments to BSUoS charges – refer to the box below.

DEVELOPMENTS TO BSUOS CHARGERS

There have been a number of recent developments to BSUoS charges, some of which are ongoing.

Storage customers are currently charged BSUoS charges as both a demand and a generation customer. Ofgem has recently approved [modifications to the CUSC](#) so that storage customers only pay BSUoS charges on exports. These modifications are intended to come into effect in April 2021.

Through Ofgem's Targeted Charging Review (TCR), Distributed Generation will no longer be able to receive payments from suppliers (an embedded benefit) for avoided Balancing Services Charges (see Page 74).

Another embedded benefit – Distributed Generation with a capacity of less than 100 MW currently avoids paying BSUoS charges, which is under review by a second Balancing Services Task Force. The [second Balancing Services Task Force](#) was asked to consider two key questions: (1) Who should be liable for balancing services charges? And (2) How should these charges be recovered? The Second Balancing Services Task Force consulted in summer 2020 and have published a [report](#) in September 2020.

The Task Force recommends that Balancing Services Charges should be levied on Final Demand only. Levying BSUoS charges onto Final Demand only will mitigate the existing distortions between GB transmission connected generators who are currently liable for BSUoS charges and interconnected and distributed

generation who are not. The first Task Force concluded that BSUoS should be a cost recovery charge, the addition of BSUoS related risk premia and transaction costs into both wholesale and retail prices is an inefficient method of cost recovery

The Task Force recommends that Balancing Services Charges should be recovered through a charge which is fixed ex ante. The Task Force recommend by majority that the charge should be volumetric (£/MWh). The combination of fixed and notice period should be 14/15 months

Definitions of LV, HV and EHV:

Term	Voltage level
LV (Low Voltage)	In general: less than 1 kV. In practice, this means 400/230 V
HV (High Voltage)	In general: 1 kV—22 kV. In practice, this means 6.6, 11 or 20 kV.
EHV (Extra High Voltage)	In general this covers connection to the distribution network at or above 22 kV. In practice this means 33 or 66 kV, (or 132 kV in England and Wales only). Some DNOs may define this slightly differently. See the definition of EHV for your local DNO.

Section 5.5: G99 Type A & Type B-D, Costs and Charges

Connection Charges – Infrastructure

The connection provides an electrical path between your generation installation and the DNO's network. Any work required to establish this connection will result in some initial costs, which will be charged to you upfront as part of the connection charge.

The work required to provide this path can be broken down into two categories:

- **New infrastructure** (or extension) must be installed to provide an extension of the existing network. This is from the point of connection on the existing network up to the new point of supply.
- Some **reinforcement** of the existing network infrastructure may be required to accommodate your planned generation capacity.

These are illustrated in Figure 16 and the point of connection is defined in the Glossary.

Reinforcement work is usually required to increase the electrical capacity of those parts of the network which form part of the electrical path from the generating equipment to the network. However, some reinforcement work does not fit this description, for example:

- It may be necessary to install switchgear at a substation some distance from your project site. This could be due to the increase in fault level caused by the connection of your generator, or to create a new protection zone.
- Equipment such as reactors or static VAR compensators may be needed for times when the voltage may rise, e.g. When your generating equipment is exporting at times of light demand.

The asset costs that are included in the connection charge include:

- Any extension to the network
- A **portion** of reinforcement costs

DNOs are obliged to publish a document describing the basis of their connection charges and their charging methodology. You can refer to this document to see what portion of reinforcement costs you will be charged for. These are available on DNO websites.

Extension and reinforcement

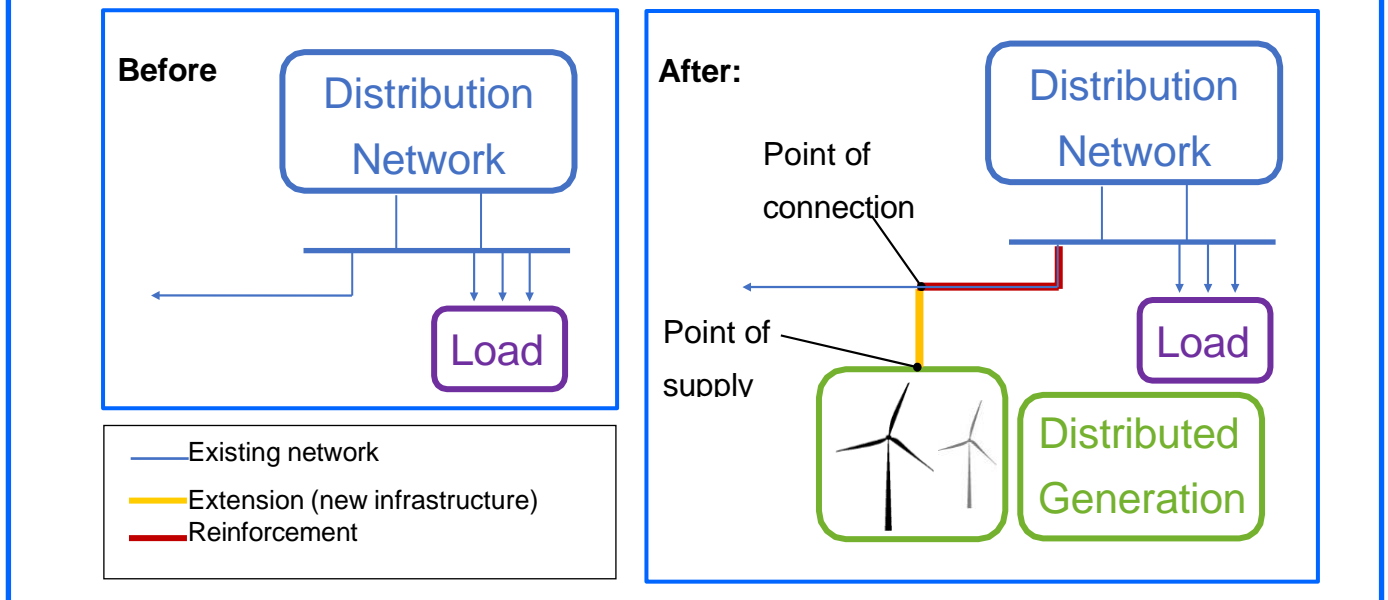

Figure 16: Illustration showing extension and reinforcement of the network.

In some cases, Distributed Generation may have an effect on the transmission network. In this case your DNO may need to request a Statement of Works from NGENSO.

Changes to Use of System Charges

Ofgem Targeted Charging Review

Ofgem has been reviewing certain elements of Transmission and Distribution Use of System charges (DUoS), in a Targeted Charging Review (TCR) Significant Code Review (SCR). This is because they had concerns that the current framework for charging may result in inefficient use of the networks and unfair outcomes for consumers. The SCR was set up in response to changes in generation, with an increasing amount of generation from smaller sources. More businesses and households are generating their own electricity onsite, but still rely on the grid for part of their supply.

The review was launched in August 2017 and Ofgem published their decision in December 2019. The outcome of the review will result in significant changes to Use of System charges, which will affect all users.

The review considered two main elements of charges:

1. Residual charges
2. Non-locational embedded benefits

Residual charges are designed to recover sufficient network costs, so that network companies can recover their allowed revenue as determined in price controls with Ofgem. They were not intended as charges to send signals for how the network should be used.

Residual charges currently make up around 50% of DUoS charges (although this varies between DNOs) and 10-15% of a typical electricity bill and are currently largely based on energy consumption from the network.

Under the old arrangement customers who reduced their demand from the network with onsite generation could reduce (or avoid) paying these charges, despite still using the network, and these avoided costs were recovered from other customers.

Ofgem's decision is that the distribution residual charge will change from one based on energy demand to a fixed charge levied on all households and businesses. The charges will be applied to final demand users (i.e. not including generation-only or storage-only connections). The fixed charges will be applied in bands, according to agreed capacity or energy demand and voltage level.

For the distribution residual charge, there will no longer be a link to time of consumption through the application of red / amber / green charging periods, although this will continue for the forward-looking element of DUoS charges. This means that customers will no longer be able to switch to behind-the-meter generation to reduce the residual element of Use of System charges.

This change is likely to impact on demand customers with onsite generation. This is because customers with onsite generation consume less from the grid, thus reducing the energy-based charge under the old arrangements. However, the final impact on bills will depend on how suppliers pass on charges to their customers.

Ofgem Access and Forward-Looking Charges

Ofgem published their final decision on the Access and Forward-Looking Charges Significant Code Review (Access SCR) in May 2022. The Access SCR was implemented to ensure that electricity networks are used efficiently and flexibly, reflecting users' needs and allowing consumers to benefit from low carbon technologies while avoiding unnecessary costs on energy bills.

The changes introduced:

1. Changes to the distribution connection charging boundary.
2. Enhanced choice of "access rights" a customer has to the network and a new standardised definition for a Curtailable Connection.
3. A new methodology for determining if a connection application relates to a site that is a Speculative Development. Where a site is determined to be a Speculative Development, the developer of such a site pays for all applicable network reinforcement costs.

The Access SCR implements these new rules via the Distribution Connection and Use of System Agreement ("DCUSA"). The characteristics of a Speculative Development are given in Schedule 22, paragraph 1.39 of the [DCUSA DCUSA Document - DCUSA](#).

The Distribution connection charging boundary determines the split between the amount paid by the connecting generator and the wider energy consumer. The changes are designed to

- Reduce the upfront costs paid by new generation connections when the network requires reinforcement
- Retaining and strengthen existing protections for energy consumers.

Under the old arrangements customers who connected to the distribution network and triggered network reinforcement had to pay a proportion of the costs at the connecting voltage level and one voltage level up. For example, if a generator connected at LV and triggered reinforcement at 11kV they contributed towards the costs at both voltage levels. The new arrangement means there will be a reduction in the contribution to reinforcement for generation connections as a 'shallow-ish' connecting charging boundary has been introduced.

Generation sites will contribute to the reinforcement costs at the voltage level of the connection. Storage sites are treated in the same way as generation. The High-Cost Cap (HCC) has been retained, above which the customer has to pay in full for the reinforcement costs. This is presently £200/kW for generation and £1720/kVA for demand. If a site has both generation or storage and demand it will be charged as a demand customer and make no contribution to reinforcement costs at the point of connection. This is summarised in the table below.

Table 11: Summary of reinforcement costs.

	Charging Boundary	Extension costs	Reinforcement costs at connecting voltage	Reinforcement costs at connecting voltage +1
New arrangement for demand connection and mixed-use sites where generation (storage) and demand are co-located	Fully shallow	Connecting customer pays 100%	Fully funded by DNO through DUoS	Fully funded by DNO through DUoS
New arrangement for generation connection	Shallow-ish	Connecting customers pays 100%	Connecting customer pays a proportion of the reinforcement costs	Fully funded by DNO through DUoS

If the connection to the distribution network triggers a transmission system upgrade the upgrade cost will continue to be charged to the connecting customer. Ofgem are considering this arrangement in their ongoing use of system work.

The reforms to the connection charging boundary came into effect in April 2023.

Ofgem has implemented changes to the access rights to the distribution network by introducing standardised Curtailable Connections. These non-firm access arrangements may enable customers to connect to the network more quickly by agreeing that their use of a connection may be restricted at certain times. The amount of curtailment a customer is subject to will be measured and compared against a defined curtailment limit, and the ability to curtail a customer will cease after an agreed end date. Should the actual curtailment exceed the agreed limit the DNO will pay the customer compensation at a published set price. A Curtailable Connection will only be offered where the DNO identifies a requirement for network reinforcement and where deploying curtailment will manage the network constraint(s) until the network reinforcement is complete. Curtailable connections will not be offered to domestic and small industrial and commercial users. These new access rights came into effect in April 2023. Full details can be found at the following link:

<https://www.ofgem.gov.uk/publications/access-and-forward-looking-charges-significant-code-review-decision-and-direction>.

Embedded Benefits

Embedded benefits are historic charging arrangements that had favoured Distributed Generation with a capacity of less than 100 MW, in terms of receiving revenue. There were four non-locational embedded benefits:

1. Transmission Demand Residual (a payment to Distributed Generation): this was the largest benefit of the four and was removed in June 2017.
2. Transmission Generational Residual: subject of this Targeted Charging Review.
3. Balancing Services Charges – payments from Suppliers: subject of this Targeted Charging Review.
4. Balancing Services Charges – avoided charges: currently an avoided charge for Distributed Generation (for capacity < 100 MW) – the Targeted Charging Review concluded that this will be addressed by a Balancing Services Task Force.

The decision reached by Ofgem on items (2) and (3) above are as follows. The Transmission Generation Residual, which was previously a payment for transmission connected generation, will be set to zero. And Distributed Generation will no longer be able to receive payments from suppliers for avoided Balancing Services Charges. The removal of these Embedded Benefits will affect all grid connected generators who currently benefit from these as a revenue stream.

Next Steps

Ofgem has directed Distribution and Transmission Licensees to carry out the work to make revisions to the relevant industry codes to enact these changes. The changes to the Distribution Residual Charge was implemented in April 2022 and the Transmission Residual Charge changes will be implemented in April 2023. The Energy Networks Association (ENA) [Project Initiation Document](#) sets out how the network companies are proposing to deliver the changes.

For more information, refer to the Ofgem webpage on the [Targeted Charging Review](#) and [Access SCR](#). There is also information on the [Charging Futures website](#).

Section 6: Selling Electricity (SEG)

This section introduces the financial incentives for selling electricity onto the distribution network.

Section 6.1: G98 & G99, Selling Electricity (SEG)

In this section:

- An introduction to the Smart Export Guarantee (SEG) Incentive
- Eligibility and Accreditation
- Deployment caps and how they work
- Guidance on where to find more information

Tip: Read the information boxes for definitions or explanations of terms that may be new or unfamiliar.

Introduction

Smart Export Guarantees (SEGs) are a financial incentive to support distributed and small-scale renewable energy generation, up to a capacity of 5 MW.

SEGs are available for the following generation technologies:

- Anaerobic digestion (AD)
- CHP and Micro-CHP
- Hydro
- Solar PV
- Wind

A number of domestic Combined Heat and Power (CHP) units are also supported through FITs under a Micro CHP pilot scheme. The Micro CHP pilot will support up to 30,000 installations with an electrical capacity no greater than 2 kW.

This section will detail the structure of the tariffs and will explain how to get accredited with SEGs.

Important Point: The SEG scheme for generators opened on the 1st January 2020. The SEG scheme replaces the Feed-in Tariff (FIT) scheme that closed on the 31st March 2019 but works differently to FITs.

There are two sources of financial benefit from FIT payments which are:

- Generation tariff: A fixed unit for each unit of electricity generated.
- Export tariff: A guaranteed price for each unit of electricity exported to the grid.

The SEG scheme obliges electricity suppliers to offer an export tariff rate to an eligible generating unit.

Generators cannot receive SEG payments as well as FIT payments for exported electricity. However, if the generator continues to receive FIT generation payments and opts out of receiving FIT export payments then they are eligible to receive SEG export tariff payments.

Tariff Structure

The main financial benefit from a generation project under the SEG scheme is the export tariff, which is a guaranteed price for each unit of electricity exported to the grid. It is an obligation for licensed energy suppliers to offer eligible generation projects an export tariff rate. The electricity suppliers decide the SEG export tariff

details i.e., the rate and the length of the contract. However, although wholesale electricity prices can fall below zero due to changes in demand, electricity suppliers must always offer a tariff which is greater than zero.

The tariffs are variable and can be adjusted annually for inflation. Generators should contact electricity suppliers in the first instance for more information on the SEG scheme and what rates are offered. A full list of the electricity suppliers that are offering payments have been published by Ofgem, and you can access them on their webpage below:

<https://www.ofgem.gov.uk/publications-andupdates/seg-supplier-list>

As an indication, at the start of 2020 the Smart Export Guarantee rates were typically in the range 1.0 – 5.6 p/kWh, depending on the supplier.

FIT Scheme – Generation and Export Tariff

Installations which receive payments under the FIT scheme will continue to receive the same generation and export tariffs that were current at the time of installation. The last export tariff under the FIT scheme, before the scheme closed on the 31st March 2019, was fixed at 5.24p/kWh. This differs from the export tariff rate offered through the SEG scheme, which depends on the electricity supplier you choose to contract with.

Metering Requirements

All new installations that wish to export renewable energy to the grid must have an export meter installed. The export meter must be capable of taking half-hourly measurements and have an export MPAN (Meter Point Administration Number). The export meter must be located at the point where the installation connects to the network. Smart meters are capable of measuring half-hourly export energy so will not need physically changing.

Your electricity supplier is a good first port of call to discuss metering arrangements. However, note that you can opt to receive SEG payments from a different electricity supplier from your import electricity supplier.

Eligibility and Accreditation

Renewable Energy generators under 5 MW are eligible for SEGs.

Accreditation steps:

For wind or solar PV generation up to and including 50 kW, and for micro-CHP, the accreditation process is as follows:

- Install your generating unit—you must demonstrate that the installation and installer are suitably certified by using a Microgeneration Certification Scheme (MCS) installer (see below);
- Install a smart meter to measure export energy every half-hourly;
- Apply for a SEG with your electricity supplier, and provide them with any documentation to demonstrate compliance so that they can verify your eligibility;
- Your electricity supplier will then be responsible for the level of payment you will receive for the electricity exported, for which you will be required to provide export meter readings.

See Ofgem's website below for more guidance into receiving SEG payments:

<https://www.ofgem.gov.uk/publications-andupdates/smart-export-guarantee-guidancegenerators>

For installations that are greater than 50 kW, you will be required to demonstrate that the installation is suitably certified. Each electricity supplier will have their own requirements for demonstrating certification, but these are expected to include the EREC G99 Installation Document and proof of ownership.

For all AD and Hydro installations, you are required to provide evidence that the installation is suitably certified for a capacity up to and including 5 MW.

For AD installations, an additional step is required to gain accreditation, which involves submitting separate and ongoing documentation to Ofgem, in the form of Quarterly sustainability declarations and Annual feedstock declarations. AD installations must use sustainable biogas in order to be eligible for SEG payments. Feedstock that is waste is considered to satisfy sustainability criteria automatically. More information is available on Ofgem's website: <https://www.ofgem.gov.uk/publications/guidance-anaerobic-digestion-generators-seg-sustainability-criteria-and-reporting-requirements>

Microgeneration Certification Scheme (MCS)

The MCS is currently the only formalised industry standard in the UK based on European and international standards for microgeneration projects. MCS is a BS EN ISO/IEC 17065:2012 Certification scheme covering Renewable Energy products wind and PV up to 50 kW (electrical), solar thermal, biomass and heat pumps up to 45 kW (thermal), Micro CHP and hydropower and Renewable Energy installation companies. MCS checks for the products' performance and quality and for the installation methods and quality. MCS will increase your confidence in the Renewable Energy technology you are buying and in the company installing it.

For more information, please refer to the MCS website: www.microgenerationcertification.org

Multi-technology sites: Electricity suppliers have an obligation to accept a request for SEG payments from a generator that is exporting from an eligible site. However, if the export meter records the energy exported from a combination of eligible and non-eligible SEG sources at the same site, an electricity supplier does not have to make payments. You should check the options and terms from different electricity suppliers carefully.

Extensions to SEG installations: The capacity of a generation unit of one particular technology can be increased. However, if the installed capacity of the generating unit exceeds 5 MW then the electricity supplier does not have to make SEG payments for the export that exceeds 5 MW. If you choose to install extra capacity at your site from a different technology source, then the electricity supplier will recognise this as a separate eligible source and will be able to make payments for the capacity of this technology up to 5 MW. For example, a 7 MW PV solar array and a 3 MW wind farm would be eligible for SEG payments for 5 MW PV and 3 MW wind.

Local Flexibility Markets: As part of the ENA Open Networks Project, a workstream dedicated to Flexibility Services (WS1A) is looking at the best way to implement markets for flexibility services offered by Distributed Generation. Where co-located with demand, Distributed Generation can offer Flexibility Services to the network by adjusting onsite demand and generation in order to keep the network balanced, relieve congestion, and release network capacity. This allows more Low Carbon Technologies (LCT), such as renewable generation, to connect to the network. The DNOs created the ENA Flexibility Commitment in December 2018, which is the first step towards expanding the Flexibility Markets to local level.

For more information refer to the ENA's website:

<https://www.energynetworks.org/creating-tomorrows-networks/open-networks/flexibilityservices>

And look for details of Flexibility Services on your DNO's website.

Where to Find More Information

For more guidance and the most up-to-date information on the Smart Export Guarantee, please see the following organisations' websites:

Section 6.1: G98 & G99, Selling Electricity (SEG)

- Ofgem – About Smart Export Guarantee (SEG)

<https://www.ofgem.gov.uk/environmental-and-social-schemes/smart-export-guarantee-seg>

- Department for Business, Energy and Industrial Strategy (DESNZ) — The future for small-scale low carbon generation: Smart Export Guarantee – government response

<https://www.gov.uk/government/consultations/the-future-for-small-scale-low-carbon-generation>

Section 6.2: G99, Contracts for Difference

In this section:

- An introduction to renewable electricity incentives
- Contracts for Difference
- The Renewables Obligation closure
- Guidance on where to find more information

Tip: Read the information boxes for definitions or explanations of terms that may be new or unfamiliar.

Introduction

This section of the Guide focuses on Feed in Tariffs with Contracts For Difference (CFD). This is the main financial incentive mechanism for larger schemes of low carbon generation. It has replaced the Renewables Obligation (RO), which closed to new applications in March 2017. The RO closure does not affect generation that was already accredited before the relevant closure date.

This section introduces the CFD mechanism, and explains how you, as a generator, can benefit. Key elements of the CFD scheme are introduced. The application process for a CFD is much more complex than for the SEG scheme. You are referred to relevant websites and documents for more information.

There are various other power trading options for Distributed Generation, including:

- Selling your electricity on the wholesale market or to an electricity supplier
- Levy Exemption Certificates (LECs)
- Embedded benefits
- Ancillary services
- EU Emissions Trading System (ETS)

These have been discussed briefly in [Section 2: The Role of Distributed Generation: Benefits of Distributed Generation](#), which also points to further reading on these topics. Beyond that, they are outside of the scope of this Guide.

Contracts for Difference (CFD)

Introduction

A Contract for Difference is a bilateral contract between a generator and the Low Carbon Contracts Company (LCCC, the CFD counterparty), which is government owned. A generator with a CFD is paid the difference between the “strike price” and the “reference price”. The strike price is an agreed price for electricity reflecting the cost of investing in low carbon generation. The reference price is a measure of the GB market price for electricity.

CFDs require generators to sell electricity into the market as usual. But to reduce their exposure to market prices, the CFD provides a variable “top up” payment. When the strike price is higher than the reference (market) price, the generator receives a payment. At times when the market price exceeds the strike price, the generator is required to pay back the difference, thus protecting consumers from over-payment.

Parties involved

A number of parties are involved in the CFD mechanism. They include, with examples of their roles:

- Government: writes the policy, specifies the eligibility criteria and sets the budgets and rounds.

- Low Carbon Contracts Company (LCCC): signs the CFD and forecasts CFD payments.
- National Grid (Electricity Market Reform (EMR) Delivery Body): runs the system for users to register, submit and manage applications; assesses the eligibility of applicants; and runs the CFD allocation process.
- EMR Settlement Ltd (Settlement Services Provider): collects metering data, calculates payments and manages the settlement of payments between generators and suppliers.
- Ofgem: regulates National Grid as the EMR Delivery Body and determines disputes.

Eligibility

There are a number of eligibility criteria for the CFD, including:

- Meet qualification requirements, e.g. evidence of planning permission, counter signed connection offers, generation type;
- Not considered an excluded applicant e.g. in receipt of another subsidy; and
- Provision of other information / data, e.g. incorporation information (details of different parties involved).

CFD Allocation

CFDs are awarded in rounds. During a round, if the specified budget for CFDs is not exceeded, all qualifying applicants will be awarded CFDs. If the budget is exceeded, the Delivery Body will run an auction to allocate CFDs.

Rounds 1 and 2 took place in 2015 and 2017 respectively, and CFDs have been allocated. In Round 1 there were 27 successful applicants, with project installed capacities ranging from 6 to 714 MW, and strike prices ranging from £50 to £119.89 (in 2012 prices). In Round 2 there were 11 successful applicants, with project installed capacities ranging from 50 kW to 1,386 MW, and strike prices ranging from £40 to £74.75 (in 2012 prices). Round 3 is now complete and Round 4 is opening in 2021.

National Grid publishes a Contract for Difference Interactive Guidance document which provides details on the CFD process. Also see DESNZ and the [EMR Delivery Body](#) websites for the latest information.

Renewables Obligation

The Renewables Obligation (RO) closed to all new generating capacity on 31 March 2017. This was previously the main incentive mechanism for larger renewable generation. The closure does not affect capacity accredited before the relevant closure date, which will continue to receive full 20 year support until the end of the scheme in 2037.

There are a number of grace periods, which allow generators to gain accreditation under the RO in certain circumstances after 31 March 2017. The availability of grace periods differs across England and Wales, Scotland and Northern Ireland .

The grace periods are available on [Ofgem's website](#).

Operators that are successful in their grace period application will have the opportunity to apply for accreditation under the RO after the 31 March 2017.

For more information on the closure of the RO, refer to [Ofgem's website](#).

Where to Find More Information

For Contracts for Difference (CFD) refer to the DESNZ website:

<https://www.gov.uk/government/collections/electricity-market-reform-contracts-for-difference>

National Grid as the Delivery Body for CFDs has a website:

<https://www.emrdeliverybody.com/cfd/home.aspx>

The Ofgem website has details on the Renewables Obligation closure:

<https://www.ofgem.gov.uk/environmental-programmes/ro/about-ro/ro-closure>

Section 7: G99 Type B-D, Technical and Commercial Interfaces

In this section:

- An introduction to competition in connections
- Contestable and Non-contestable work
- The National Electricity Registration Scheme (NERS)

Introduction

In getting a connection, you have two options:

1. **DNO Connection:** the DNO undertakes all the work necessary to provide the connection. Sometimes called a “statutory” or Section 16 connection.
2. **ICP Connection:** an Independent Connections Provider (ICP) provides the ‘contestable work’, and the DNO completes only the ‘non-contestable’ work (see next page for more information).

DNO connections

You will be charged the cost of the connection works as discussed in Costs and Charges: Connection charges. In practice, the DNO will undertake the design of the connection infrastructure, but the installation work will often be undertaken by another organisation under contract to the DNO.

ICP connections

This option to contract with third parties to do connection work is known as “Competition in Connections”. A choice of connections providers may bring about some advantages:

- Prices are competitive
- Timescales are within your own influence

You should take note of the following in deciding to have an ICP connection:

- Connection work constructed by ICPs is subject to inspection and approval by the DNO. You will be charged for ICP design approval by the DNO.
- There is an relationship between the ICP and DNO (see the diagram on page 90), which needs to be managed. This may take time and effort.

See below for information on the Competition in Connections Code of Practice.

Competition in Connection (CiC) Code of Practice (CoP)

In 2014/15 Ofgem conducted a review into the Electricity Connections Market, covering the market for new connections to distribution networks, and assessing the effectiveness of competition. Ofgem concluded that DNOs should be required to produce and adhere to a Competition in Connections Code of Practice. The aim of the CiC CoP is to formalise the arrangements between DNOs and ICPs, to allow effective competition for connections, as well as improving consistency in approaches across DNOs. The document is primarily aimed at third-party connection providers, but you may find it of interest. The CiC CoP is published by DNOs at:

<https://www.connectionscode.org.uk/>

DNOs also publish the CiC CoP on their websites, as well as annual reports demonstrating their compliance with the CoP.

Contestable and Non-contestable Work

There are certain tasks that DNOs do themselves, so that they can maintain coordination and control of their network. This part of the connection work is called Non-contestable work as it is not open to competition. Conversely, the part of the work that is open to competition is referred to as Contestable work.

Each DNO provides its own definition of Contestable and Non-contestable work in their Connection Charging Methodology, available on their website. Although the definitions may vary, they are broadly similar. The table below shows which activities are typically Non-contestable and which are Contestable. Note that activities to do with the existing network are Non-contestable. In addition to paying the ICP for carrying out the Contestable work, you will be charged for:

- the costs incurred by the DNO in carrying out the Non-contestable work; and
- the inspection and approval by the DNO of the work carried out by the ICP.

These charges are discussed in Costs and Charges: Connection costs.

Table 12: Contestable and Non-contestable work definitions.

	Typical Non-contestable activities	Typical Contestable activities
Activities to do with the existing network	<ul style="list-style-type: none"> • Deciding on the point of connection to the existing network • Live electrical work to connect the new extension to the existing network • Design and construction of reinforcement upstream of point of connection 	
Activities to do with new assets	<ul style="list-style-type: none"> • Obtaining any necessary consents and wayleaves involving exercising statutory powers • Design approval • Inspection, monitoring and testing of Contestable work. 	<ul style="list-style-type: none"> • Obtaining wayleaves that do not require the DNO to exercise its statutory powers • Detailed design for on-site works downstream of the point of connection to the existing network • Project managing the connection • Providing materials to DNOs' specification • Cable trenching, installing ducts and other preparation of the site • Carrying out substation building and civil work on-site • Constructing the extension • Recording of work, cable routes and equipment on site and the provision of this information to the DNO • Installing metering and making internal wiring live (this is undertaken by your supplier rather than an ICP)

National Electricity Registration Scheme

Lloyds register operates the National Electricity Registration Scheme (NERS) on behalf of DNOs. Under the NERS, ICPs are assessed and accredited for various items of Contestable work. For example, they may only be accredited for work up to a certain voltage level.

DNOs stipulate that all or most items of Contestable work need to be carried out by accredited ICPs. A list of accredited ICPs can be found on the [Lloyds register website](#).

Some items of Contestable work may not have to be carried out by an accredited ICP, for example cable trenching work on site. Consult your DNO's Connection Charging Methodology for details on which parties can undertake items of work.

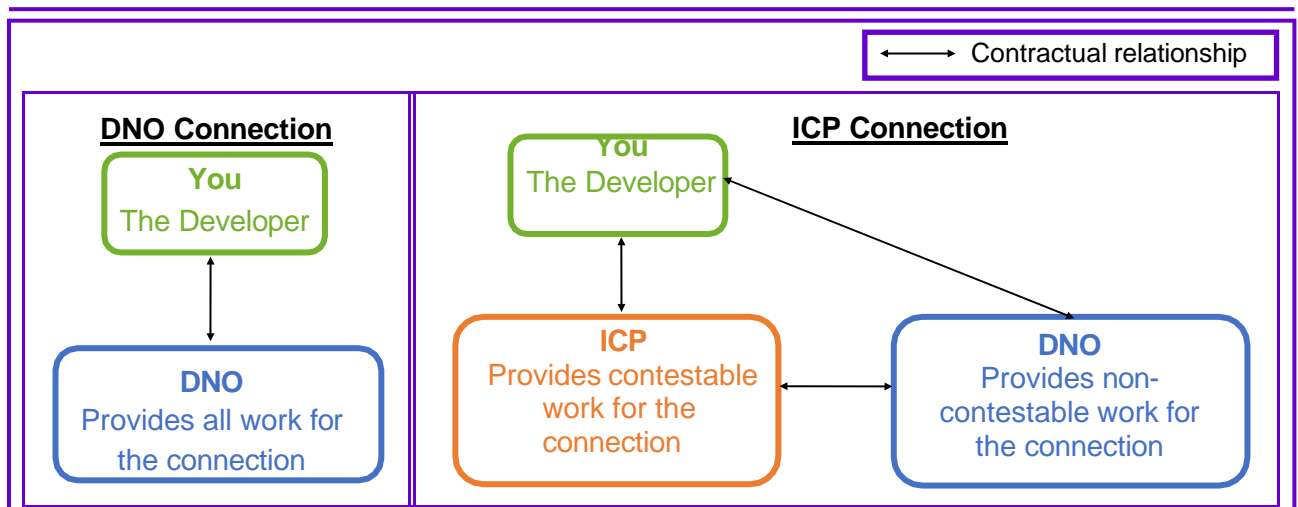

Figure 17: Contractual relationships in the connection process.

Practicalities of ICP Connections

If you want to get ICP quotations for connection work, you first need to establish:

- the scope of the work that is Contestable;
- the relevant standards for the specification of work, materials and equipment; and
- details of approved contractors.

The DNO defines the scope of Contestable work, although they may be open to negotiation on some points. This is normally provided in the connection quotation if you have requested this information at the application stage.

The DNO will have preferred design standards and preferred specifications for materials and equipment. However, you should be aware that statutory requirements based on national and international standards for connection works are set out in the Distribution Code. DNOs are entitled to seek clear confirmation and proof that these standards are met. They may charge for additional operating costs imposed by equipment that is otherwise unique on their systems.

On making a request for a connection quotation, you should indicate to your DNO if you're interested in obtaining ICP bids for Contestable work and ask for the quotation to show charges for Contestable work and Non-contestable work separately. You could also ask the DNO for details of approved contractors and for their preferred design standards and equipment specifications.

If you decide to contract with an ICP it is your responsibility to ensure that the ICP's work is acceptable to the DNO under the terms of the Adoption Agreement (discussed in [Section 7: Technical and Commercial Interfaces: Contracts with the DNO](#)). So before contracting with an ICP, you should ensure that their bid:

- covers all the necessary items of work;
- provides materials and equipment which comply with the requirements of the Adoption Agreement.

You should keep the DNO fully informed of the source and specification of equipment to be procured or installed. It may be prudent to set up a design review to enable the DNO to formally review and approve the contractor's proposed scope of supply.

Contracts and Agreements

In this section:

- An introduction to contracts required with the DNO
- Information on Connection Agreements and Adoption Agreements
- Agreements with other parties

Tip: Read the information boxes for definitions or explanations of terms that may be new or unfamiliar.

Introduction

Before you can start operating your generating units, you will need to enter into a number of agreements with the DNO, which may include:

- A Connection Agreement
- An Adoption Agreement, where you have contracted an ICP

These contractual relationships will be discussed in this section, and the terms are defined briefly in the information box on the next page.

Connection Agreements

You will be required to enter into a Connection Agreement with your DNO. The Connection Agreement covers the conditions under which your equipment is entitled to be:

- Physically connected to the DNO's network; and
- Remain connected and energised during normal operation of the network.

Examples of some of the areas covered in the Connection Agreement include:

- identifying who is responsible for equipment maintenance and recording failures;
- key technical data such as import and export capacities;
- arrangements for communication links between you and the DNO;
- obligations on the DNO regarding the connection, and obligations on you such as paying the connection charge and complying with the Distribution Code.

The Connection Agreement is likely to take the form of a standard document with project specific annexes. A first draft will probably be prepared by the DNO for discussion, agreement, and signature. DNOs discuss the Connection Agreement in their Connection Charging Methodology, available on their website. There is also more about the Connection Agreement in EREC G99.

Adoption Agreements

If you use an ICP to construct the Contestable work for your connection, you will have to enter into an Adoption Agreement. This covers the arrangements for the DNO to take over responsibility for the infrastructure installed by the ICP. It also includes arrangements to ensure that the work meets the DNOs' requirements.

Adoption Agreements take one of several forms:

- a tripartite agreement between you, the DNO and the ICP;
- a bipartite agreement between you and the DNO;
- a bipartite agreement between the DNO and the ICP; and
- a multipartite agreement between you, the DNO, the ICP and any relevant third party landowners.

DNOs discuss the Adoption Agreement in their Connection Charging Methodology, which are available on their websites. You should consult this document to find out which form of agreement your DNO specifies.

Agreements with Other Parties

You may also need to enter into agreements with other parties including:

- Terms for 'Use of System' are either covered by
- the agreement you will have with your supplier, who is a party to the DCUSA. This is the most likely option.
- entering into a 'Distribution Connection and Use of System Agreement'(DCUSA). See the DCUSA website: www.dcusa.co.uk
- Agreements with NGENSO, which will be either a 'Bilateral Embedded Generation Agreement' (BEGA) or a 'Bilateral Embedded Licence Exemptible Large Power Station Agreement' (BELLA) (see [Section 4: The Connection Application: Generation Licensing](#))
- An agreement for electricity supply with a supplier
- A Power Purchase Agreement or an agreement with your supplier for selling your exported electricity
- Metering Agreements (see [Section 5: Costs and Charges: Ongoing charges](#))

Agreements at a glance

Connection offer: A formal offer from the DNO containing terms, conditions and charges for the DNO to make the connection. Issued either to you or the ICP where applicable.

Connection Agreement: An agreement between you and the DNO detailing terms and conditions for connecting to and remaining connected to the DNO's network.

Adoption Agreement: An agreement which sets out the terms and conditions for the DNO to adopt assets which have been constructed by an ICP.

Operational Issues

In this section:

- An introduction to some operational issues
- Distribution Operating Code requirements
- DNO control schemes

Introduction

Once your generating units have been connected, you still have some ongoing responsibilities around running your generating equipment. For example, you may need to provide the DNO with forecasts of your generation, or exchange information with them if an unusual event occurs. Although the focus of this Guide is on the connection process for Distributed Generation, this section will also touch on some operational issues.

There are different requirements for different categories of Distributed Generation. These are outlined in a section of the Distribution Code, which is discussed in more detail in this section.

The day-to-day running of your generating equipment may also be impacted by control schemes which your DNO may apply. If your DNO does apply an operational control scheme this will be detailed in your Connection

Agreement, so that is the first place you should look. These schemes are discussed briefly, and we will point you in the direction of sources for more information.

Distribution Operating Code

The Distribution Operation Code (DOC) is a section of the Distribution Code. The requirements of the DOC are set out on the next page, and include:

- operating procedures at the interface between the DNO and users of the distribution network; and
- requirements for certain users of the distribution network to provide data to the DNO on load forecasts and/or generation output.

The DOC covers ten different aspects of information exchange or procedures. Some will apply to all Distributed Generation, others only to generators of a certain size. For full information on the DOC, please refer to the Distribution Code, which is available free of charge on the Distribution Code website: <https://dcode.org.uk/the-gb-distribution-code-review-panel.html>

The areas covered are summarised in the following table, as well as who they apply to.

Table 13: Summary of DOC sections.

DOC Section	Applies to:	Brief Overview
DOC1	All Distributed Generation over 5 MW, and over 1 MW where the DNO considers it appropriate	Demand forecasting: the generator has to provide generation output forecasts to the DNO.
DOC2	Distributed Generation with output greater than 1 MW	Operational planning: you have to provide an outage program for your Distributed Generation to the DNO, and the DNO provides you with information on possible constraints on their system.
DOC5	All Distributed Generation Medium power stations that don't have an embedded generation agreement	Testing and monitoring: the DNO may need to test the quality of supply or the active / reactive power transfer at your point of connection. If they need to do this they will advise you about it, and you will be able to witness the tests and/or know the results. Up to twice a year, National Grid Electricity System Operator (NGESO) may ask the DNO to ask Distributed Generation for a statement of compliance with the relevant Grid Code conditions.
DOC6	Not applicable to Distributed Generation	Demand control

DOC7	Distributed Generation connected at HV	Operational Liaison: you and the DNO may need to exchange operational information or information about events. In order to do this, an effective means of communication needs to be established. The DNO needs to be regularly updated with your contact information.
DOC8	All Distributed Generation (excluding offshore)	Safety co-ordination: requirements to ensure the safety of people who may be working on the boundary between the DNO and Distributed Generation.
DOC9	All Distributed Generation (excluding offshore)	Contingency planning: sets out the co-ordination that is needed between all users under abnormal conditions.
DOC10	Distributed Generation connected at HV	Operational event reporting and information supply: you have to report significant events, and where necessary conduct joint investigations with the DNO.
DOC11	All Distributed Generation (excluding offshore)	Numbering and nomenclature of electrical apparatus at ownership boundaries: if you or the DNO install or change apparatus at an ownership boundary the owner of the apparatus must be notified about the numbering and nomenclature.
DOC12	Distributed Generation connected at HV	System tests: if anyone intends to undertake system tests which will affect other users, they need to follow this procedure.

DNO Control Schemes

When distribution networks were built, they were not designed to connect lots of Distributed Generation. Instead, the power system was designed to transmit bulk power from a number of large power stations to the distribution network, and then in turn distribute power from bulk supply points to demand customers.

There has been significant growth in electricity generation customers. Some distribution networks in densely populated areas are reaching the limits of their thermal and fault level capacity to accommodate more generation.

So there are several reasons why reinforcements may be required to connect Distributed Generation, including:

- Increased power flows "up" the network means that parts of the network are approaching their thermal limits.
- Changing power flows "up" and "down" the network means that the equipment installed to control network voltage might not work effectively.
- The currents that would flow in the event of a fault on the network would exceed the capability of the equipment, including protection equipment.

Reinforcement has associated costs, as discussed in [Section 5: Costs and Charges: Connection charges and Costs and Charges: Ongoing charges](#).

Depending on the particular issue, a possible alternative to reinforcement could be a DNO control scheme for Distributed Generation. For example, Distributed Generation can remain connected under normal operating conditions but under certain operating conditions their output may be constrained. It should also be noted that

constraining the output from the generating units can affect the economics of a project. There is more information on this in earlier sections of this Guide (Active Network Management on page 37 and Flexible Connection Offers on page 92 and 103).

For more on this topic, you may wish to refer to the following reports:

- DTI (Department for Trade and Industry, now DESNZ) “Solutions for the Connection and Operation of Distributed Generation” by the Distributed Generation Co-ordination Group.
- Engineering Report (ERep) 124: Guidelines For Actively Managing Power Flows Associated With The Connection Of A Single Distributed Generation Plant
- Engineering Report (ERep) 126: Guidelines for actively managing voltage levels associated with the connection of a single distributed generation plant

Note: EReps 124 and 126 are available to buy on the Energy Networks Association website.

Glossary of Terms

Generating Unit: Any apparatus which produces electricity.

Generator: A person who generates electricity under licence or exemption under the Electricity Act 1989.

Grid Supply Point (GSP): Any point at which electricity is delivered from the National Electricity Transmission System to the DNO's Distribution system.

Independent Distribution Network Operator (IDNO): A holder of a distribution licence, an IDNO designs, builds, owns and operates a distribution network, which is an extension to existing DNO network. They typically build network for new developments such as business parks, retail and residential areas and leisure facilities.

Low Voltage (LV): A voltage normally exceeding 50 V AC between conductors and earth or 120 V DC between conductors but not exceeding 1000 V AC or 1500 V DC between conductors or 600 V AC or 900 V DC between conductors and earth.

Micro-generator: A source of electrical energy and all associated interface equipment able to be connected to an electric circuit in a Low Voltage electrical installation and designed to operate in parallel with a public Low Voltage Distribution Network with nominal currents up to and including 16 A per phase.

National Electricity Transmission System Operator (NETSO): Operates the electricity transmission system in England, Wales and Scotland (see System Operator).

National Grid Electricity System Operator (NGESO): Operates the transmission system in England, Wales and Scotland (takes the role of the NETSO). NGESO is a member of the National Grid group of companies.

National Grid Electricity Transmission (NGET): Owns the electricity transmission network in England and Wales. NGET is a member of the National Grid group of companies.

National Grid Electricity Distribution (NGED): Owns the electricity distribution network in East and West Midlands, South Wales and Southwest of England. NGED is a member of the National Grid group of companies.

Ofgem: The Office of Gas and Electricity Markets.

Reinforcement: Reinforcement work is usually required to increase the electrical capacity of those parts of the network which are affected by the introduction of new generation or demand. Other work might include upgrading the switchgear at a substation some distance from the proposed generation project, due to the increase in fault level caused by the connection of generating equipment.

Renewable Obligation Certificates (ROCs): A green certificate issued to an accredited generator for eligible renewable energy generated within the UK and supplied to customers within the UK by a licensed electricity supplier. ROCs are issued for each MWh of eligible renewable output generated, the amount of ROCs received depend on the technology of the generating station.

Retail Price Index (RPI): General purpose measure of inflation used in the UK.

Reverse Power Flows: Power flows in the opposite direction to those associated with the consumption of electricity by users.

Site Responsibility Schedule: Also called a **Joint Operational Agreement**. A schedule defining the ownership, operation and maintenance responsibility of equipment and Apparatus at the Point of Supply of the DNO.

Supplier (Electricity Supplier): Electricity suppliers purchase electricity (on the market or in contracts) and sell electricity to customers (commercial, industrial and domestic).

System Operator (SO): The operator of the transmission networks, the System Operator balances supply with demand on a minute by minute basis.

System Voltage: The voltage at which an electrical network is operated.

Thermal Rating: The current-carrying capacity of a cable, an overhead line or any other item of electrical infrastructure, which is determined by the heating effect arising from electrical losses.

Transmission Network (System): A system of electricity lines and equipment owned by the holder of a Transmission Licence and operated by the GB SO, which interconnects Power Stations and substations. In England and Wales the transmission system is the equipment principally rated above 132 kV while in Scotland they are those principally at or above 132 kV.

Type Tested Equipment: Equipment that has been tested in accordance to ensure that it meets the requirements of EREC G98 or G99. Using type tested equipment simplifies the connection and commissioning process.

Use of System (UoS): The use of a transmission or distribution system by a generator, supplier, customer or an interconnected party for the purposes of transporting electricity.

Voltage Flicker: Voltage flicker is a deviation in system voltage, where power is not completely lost. Flicker may be defined as the sensation experienced by the human eye when illumination levels change as a result of the change in voltage.

Voltage Fluctuation: Fluctuations in the supply voltage that can be caused by a fluctuating load, and which in turn cause flicker.

Voltage Unbalance: Occurs where there exists a difference in voltage magnitude between phases and/or a shift in the phase separation from 120° (for a three-phase system).

Appendix A

Examples showing the process for inverter sizing and determining registered capacity

Example 1

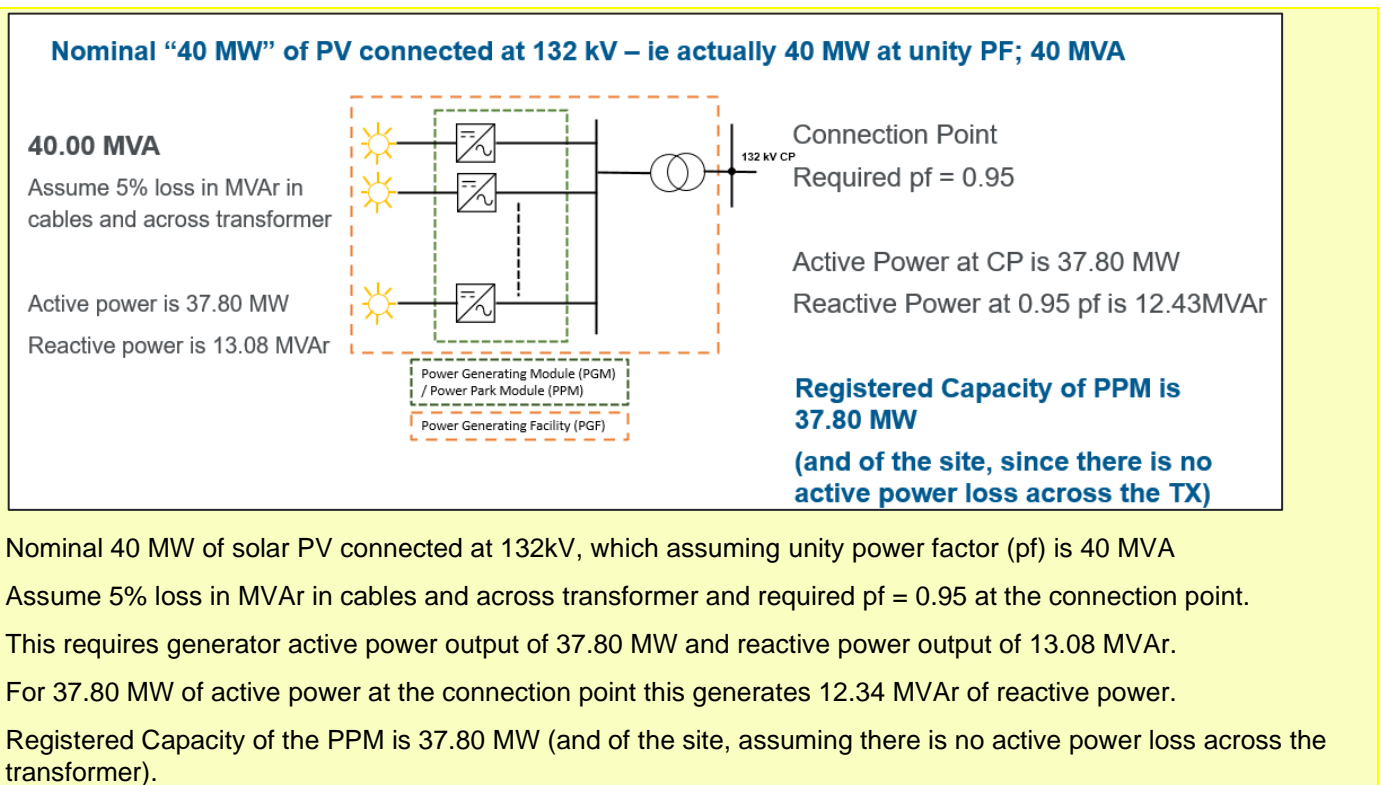

Example 2:

If at least 40 MW is to be exported:

Assume 5% loss in MVAR in cables and across transformer

40.00 MW
13.84 MVAR
42.33 MVA

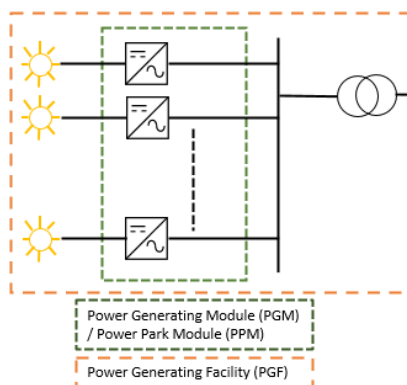

40.00 MW
Connection Point
0.95 pf
Required reactive power 13.15 MVAR
42.11 MVA

Registered Capacity of facility is 40.00 MW

Need to have 42.33 MVA of inverter capacity.

40 MW is to be exported to the network.

Assume 5% loss in MVAR in cables and across transformer. This generates 13.84 MVAR and 42.33 MVA.

40 MW at the connection point with 0.95 PF requires 13.15 MVAR and 42.11 MVA.

The total registered capacity of the facility is 40 MW. Need to have 42.33 MVA of inverter capacity.

Example 3:

If at least 40MW is to be exported and TX losses are not negligible:

43.10 MVA

Assume 2% loss in MW and 5% loss in MVAR in cables and across transformer

Active power is 40.82 MW
Reactive power is 13.85 MVAR

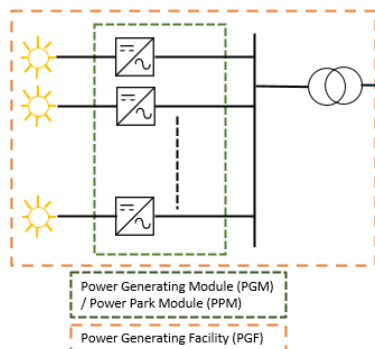

Connection Point
Required pf = 0.95

Active Power at CP is 40.00 MW
Reactive Power at 0.95 pf is 13.15 MVAR

Registered Capacity of PGM is 40.82 MW
Registered Capacity of facility is 40.00 MW

Need to have 43.10 MVA of inverter capacity.

At least 40 MW is to be exported and transformer losses are not negligible.

Assume 2% loss in MW and 5% loss in MVAR in cables and across transformers. This produced Active power of 40.82 MW, reactive power of 13.85 MVAR and apparent power of 43.10 MVA.

40 MW at the connection point with 0.95 PF requires 13.15 MVAR.

Registered Capacity of PGM is 40.82 MW.

Registered Capacity of facility is 40 MW.

Need to have 43.10 MVA of inverter capacity.

Installer Guidance

These load management techniques can effectively manage generation on a domestic property. For instance, load-limiting devices and load shedders can ensure a property doesn't exceed its grid export limits when using solar panels or other generation methods. When applied to generation, these techniques can be used to maintain a stable balance between the production and distribution of energy within the property, as well as manage the energy exported back to the grid. This is particularly valuable in homes with renewable energy sources like solar panels or wind turbines, where energy production can be unpredictable and varies with environmental conditions. These techniques provide a flexible and adaptable framework for managing both consumption and generation of energy in a domestic setting.

Solution	Description	Most Applicable Scenario
Load-limiting devices	Restricting the amount of energy, a single property can draw from the network. Each load limiting/management device must be defined, and the application of load management specified. All devices and installations must meet specific standards, as per EREC G100. Additional features: Audio alerts for excessive usage and physical limitations on energy draw.	Useful for retrofitted properties, premises with high overall loads, or when the supply becomes compromised or unsafe. Also applicable for legacy structural supplies with insufficient cables or looped services.
Load shedders	Restricting the amount of energy, selected device(s) can draw when electrical demand exceeds a predetermined level. Additional features: Audio alerts for excessive usage and physical limitations on energy draw.	Customer wishes to determine which non-essential devices can be subjected to load shedding. Recommendations are made on device usage, focusing on high-powered non-essential loads to optimize energy. Installer recommendation for essential and non-essential/customer deciding with guidance recommendations: <ol style="list-style-type: none"> 1. Prioritisation of heat pump, then EV turns on once there is sufficient load. 2. G100 limitation scheme for management of the load Automatic process/switching
Heat Pumps: Thermal Storage	A complimentary system used when there is a need to reserve	Useful for large domestic houses, such as many-bedroomed

	power draw for other devices. This solution can work around predetermined times that will not infringe on critical customer schedules.	properties or additional installations which expand the heating network. Also applicable based on customer affordability.
Heat Pumps: Immersion Heater (For Legionnaires)	Setting different times (when a customer is not using a device with high load draw) across multiple/any installation for the auxiliary heat to initiate.	Use the last digit of the serial number of the HP, to determine the hour when the immersion heater will activate, to randomise the activation time. Activation to be only between Midnight and 7am, to avail of off peak tariffs. If the SN ends in an 8 or 9, use the next digit to the left. If that digit is also an 8 or 9, keep going to the next digit to the left until you get a digit between 0 and 7. This will be the hour to set the immersion heater activation. This digit will also be the day of the week, so a SN ending in a 6 will be set to activate at 6am on a Saturday (assuming Monday is day 1)
Backup heat: Increasing room/water temperature	Activated when the heat pump is unable to maintain the desired temperature due to very low outdoor temperatures or system malfunctions.	Harsh cold temperatures where heat pumps may struggle to maintain desired indoor temperatures. It's also applicable in any setting with a heat pump where there's a risk of malfunction (due to hardware/not enough capacity available).
Installation of additional sub-panels	<i>Most properties have a singular main panel for power distribution between all circuits. Use alternative panels for easier load distribution management.</i>	Properties with complex electrical needs Homes with extensive home automation systems, multiple LCTs, or outbuildings that require power. Customer confirmed to prioritise devices in times of excess load.
Upgrading to a three-phase supply (subject to excessive of 100A/23kVA/small service cables/looped services)	Installer will accommodate environments/situation of customer/location. They will use a referred document to check which cable services/cut out apply and their respective ratings.	Property registered for use of APIs/data/Identify Power requirements are significant Single-phase supply is insufficient

<p>Recommendation of battery installation with G100 load limiting</p>	<p>G100 load limiting technology, which effectively manages power and optimizes performance; the system can regulate and limit the load to prevent overloading and potential damage</p>	<p>High-fluctuations in power loads (multiple LCTs turning on in conjunction)</p>
<p>Request to DNO for reinforcement</p>	<p>The installer recommends that reinforcement is ultimately required due to the increased load and is responsible for the explanation/justification to DNO.</p>	<p>When no other previous solution is applicable to the customers' situation. Significant additional load in a local area.</p>
<p>Removal of deterministic solutions once reinforcement/upgrade is completed</p>	<p>After the notification of increased capacity, if the customer decides to remove the solution, it becomes their responsibility to recontact the installer</p>	<p>All scenarios, should the customer want to fully utilise the equipment that they have paid to be installed.</p>

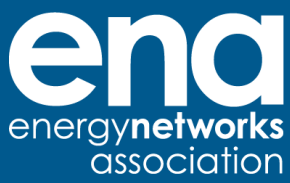

Energy Networks Association

4 More London Riverside

London SE1 2AU

t. +44 (0)20 4599 7700

w. energynetworks.org

 @EnergyNetworks

© ENA 2023

Energy Networks Association Limited is a company registered in England & Wales No. 04832301
Registered office: 4 More London Riverside, London, SE1 2AU